

SD 60 Hz



Submersible borehole pumps for 4" and 6" wells
Bombas sumergibles para pozos de 4" y 6"



Coverage chart - Campo de aplicaciones

$n \approx 3450$ 1/min

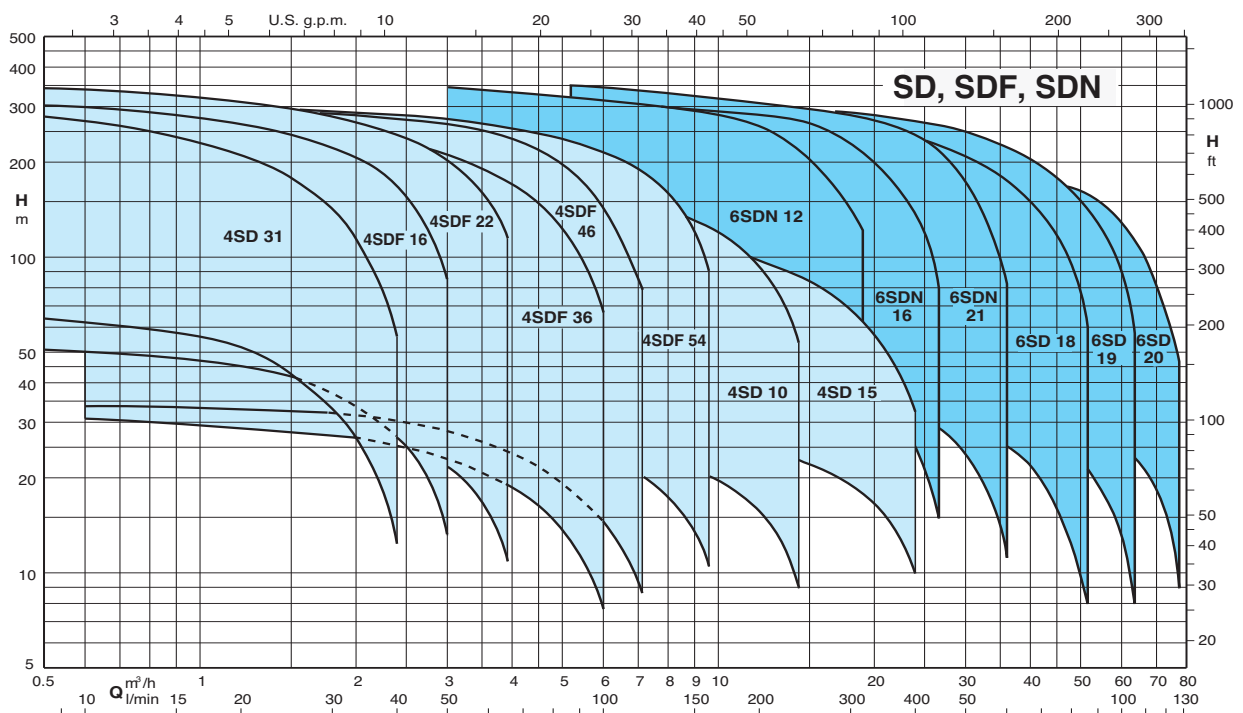

Construction

Submersible borehole pumps for 4" wells (DN 100), and 6" (DN 150), with external jacket in stainless steel AISI 304 and stages in polycarbonate for 4SD pumps and in Noryl for 4SDF, 6SD, 6SDN pumps.

Impellers

radial floating impellers	4SDF 16, 22, 36, 46, 54
radial impellers	4SD 31, - 6SDN 12, 16, 21
mixed flow impellers	4SD 10, 15 - 6SD 18, 19, 20

Connection: threaded ports **ISO 228/1**.
threaded ports **NPT (ANSI/ASME B1.20.1)** on request only for 4"

Delivery casing with built-in non-return valve.

Applications

For water supply.
For civil and industrial applications.
For irrigation.

Operating conditions

Max. sand quantity into the water: 150 g/m³ (300 g/m³ high percentage of solids and sand).
Continuous duty.

Rewindable motor CS series

2-pole induction motor, 60 Hz (n = 3450 rpm).
Sized for connection to the pumps according to NEMA Standards.
Standard voltages:

- single-phase 110 V up to 0,75 kW;
127 V up to 1,1 kW;
220 V up to 2,2 kW
- three-phase 220 V; 380 V; 440 V, 460 V;
220/380 V; 380/660 V.

Voltage tolerance : ±10%.

Recommended type of starting for powers from 7.5 kW: star/delta, soft start, impedance starting, autotransformer.

Motor	Max. Liquid temperature	Cooling: minimum flow velocity	Max. starts per hour	Motor P2
4CS	35 °C	0,08 m/s	20	all types
6CS-R	30 °C	0,1 m/s	15	4÷11 kW
		0,2 m/s	15	13÷15 kW
	25 °C	0,2 m/s	15	18,5 kW
		0,2 m/s	13	22÷30 kW
	40 °C	0,1 m/s	13	37 kW
		0,3 m/s	6	45 kW

Insulation class F for 4" motors, PVC coated wire for 6" motors.
Protection IP 68.

Special features on request

- Other voltages. - Other temperatures.

Materials

Components	4SD, 4SDF	6SD, 6SDN
External jacket	Cr-Ni steel AISI 304	
Stage casing (4SDF)	Cr-Ni steel AISI 304	-
Stage casing (4,6SD)	Polycarbonate (Lexan 141 R)	GFN2V* (NORYL®)
Diffuser	GFN2V* (NORYL®)* for 4SDF	
Impeller		
Wear ring	Cr-Ni steel AISI 304	
Shaft	Cr steel AISI 430 F	
Delivery casing	Cr-Ni steel AISI 304	Bronze
Suction lantern		G-Cu Sn 10 EN 1982
Bearing bush	Thermoplastic	Rubber
Strainer	Cr-Ni steel AISI 430	
Screws	Cr-Ni steel AISI 304	

* Trademark of General Electric

Ejecución

Electrobombas sumergibles para pozos profundos 4" (DN 100 mm), 6" (DN 150 mm), con camisa externa en acero inoxidable AISI 304 y cuerpos elementos in policarbonato para 4SD en NORYL® para 4SDF, 6SDN.

Rodetes:

flotantes a flujo radial	4SDF 16, 22, 36, 46, 54
radiales	4SD 31, - 6SDN 12, 16, 21
semi-axiales	4SD 10, 15 - 6SD 18, 19, 20

Conexión: Roscados **ISO 228/1**.
Roscados **NPT (ANSI/ASME B1.20.1)** bajo demanda solamente para 4".

Válvula de retención incorporada en el cuerpo de impulsión.

Aplicaciones

Para suministros de agua.
Para aplicaciones civiles e industriales.
Para riegos en general.

Limites de empleo

Máxima cantidad de arena en el agua: 150 g/m³ (300 g/m³ alta porcentaje de sólidos y arena)
Servicio continuo.

Motor rebobinable serie CS

Motor a inducción 2 polos, 60 Hz (n = 3450 1/min).
Dimensiones para el acoplamiento a la bomba según NEMA Standard.
Tensiones de alimentación:

- monofásicos 110 V - hasta 0,75 kW;
127 V - hasta 1,1 kW;
220 V - hasta 2,2 kW.
- trifásicos 220 V; 380 V; 440 V;
220/380 V; 380/660 V.

Variación de tensión : ±10%

Tipo de arranque aconsejado para potencias desde 7.5kW: estrella/triángulo, soft start, o con impedancia.

Motores	Temperatura del agua hasta	Refrigeración: velocidad mínima del caudal	Arranques por hora máximos	Motores P2
4CS	35 °C	0,08 m/s	20	todos
6CS-R	30 °C	0,1 m/s	15	4÷11 kW
		0,2 m/s	15	13÷15 kW
	25 °C	0,2 m/s	15	18,5 kW
		0,2 m/s	13	22÷30 kW
	40 °C	0,1 m/s	13	37 kW
		0,3 m/s	6	45 kW

Aislamiento clase F para motores 4", hilo con revestimiento en PVC para motores 6".
Protección IP 68.

Ejecuciones especiales bajo demanda

- Otras tensiones. - Otras temperaturas.

Materiales

Componentes	4SD, 4SDF	6 SDN
Camisa externa	Acero Cr-Ni AISI 304	
Cuerpo elemento (4SDF)	Acero Cr-Ni AISI 304	-
Cuerpo elemento (4,6SD)	Polycarbonato (Lexan 141 R)	GFN2V* (NORYL®)
Diffusor	GFN2V* (NORYL®)* para 4SDF	
Rodete		
Anillo de cierre	Acero Cr-Ni AISI 304	
Eje	Acero Cr AISI 430 F	
Cuerpo de impulsión	Acero Cr-Ni AISI 304	Bronze
Lantern de aspiración		G-Cu Sn 10 EN 1982
Cojinete guía	Termoplástico	Goma
Filtro	Acero Cr-Ni AISI 430	
Tornillo	Acero Cr-Ni AISI 304	

* Marca registrada de General Electric

4SD 31 60 Hz



Performance - Prestaciones $n \approx 3450$ rpm, dimensions and weights - dimensiones y pesos

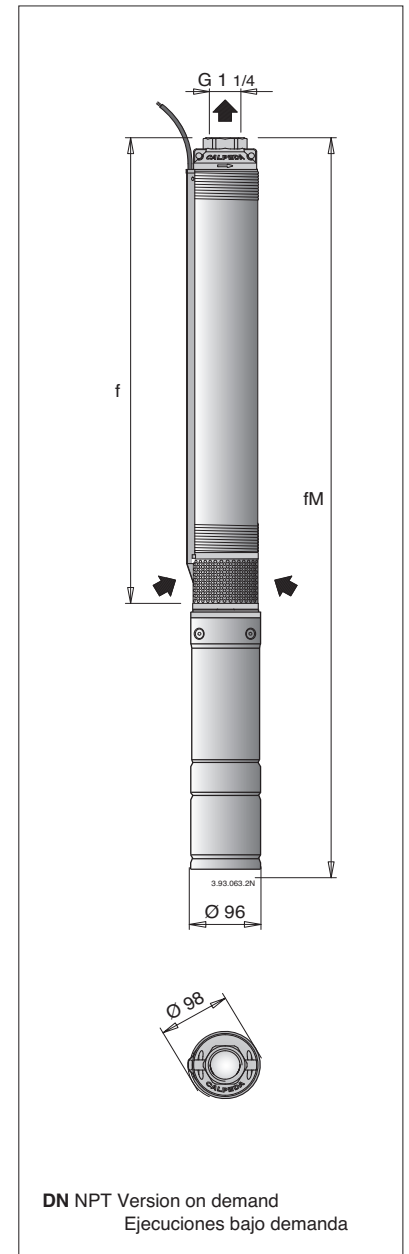
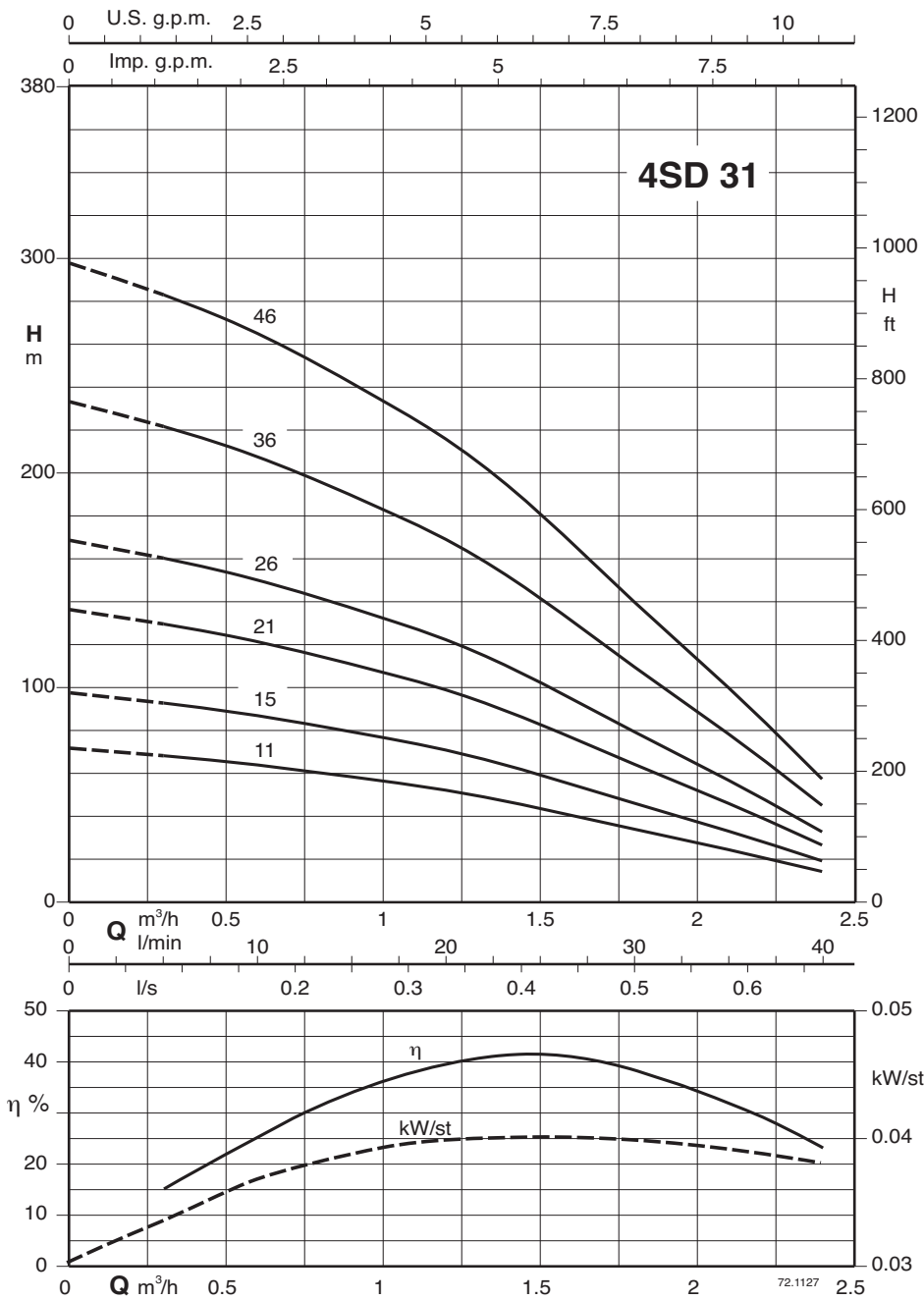

3~	1~	P ₂		Q	n ≈ 3450 1/min											4SD		4SDM	
		kW	HP		0	0,3	0,6	0,9	1,2	1,5	1,8	2,1	2,4	f	fM	kg	fM	kg	
4SD 31/11EC-60	4SDM 31/11EC-60	0,37	0,5	71	67,5	63,5	58	51,5	42,5	33,5	24	13,5	473	800	10,3	800	10,2		
4SD 31/15EC-60	4SDM 31/15EC-60	0,37	0,5	97	92,5	84,5	79	70,5	57,5	45,5	32,5	18,5	550	877	10,9	877	10,8		
4SD 31/21EC-60	4SDM 31/21EC-60	0,55	0,75	136	130	121	110	98,5	80,5	64	45,5	26	670	1017	13	1032	13,5		
4SD 31/26EC-60	4SDM 31/26EC-60	0,75	1	168	160	150	137	122	100	79	56,5	32	768	1130	14,8	1170	15,8		
4SD 31/36EC-60	4SDM 31/36EC-60	1,1	1,5	233	222	207	189	169	138	109	78	44,5	965	1367	17,7	1412	18,4		
4SD 31/46EC-60	4SDM 31/46EC-60	1,5	2	298	283	265	242	216	177	140	99,5	57	1160	1607	20,2	1627	20,4		

P₂ Rated motor power output.
Potencia nominal del motor.

H Total head in m
Altura total en m

Tolerances according to UNI EN ISO 9906:2012.
Tolerancias según UNI EN ISO 9906:2012.

4SDF 16 60 Hz



Performance - Prestaciones $n \approx 3450$ rpm, dimensions and weights - dimensiones y pesos

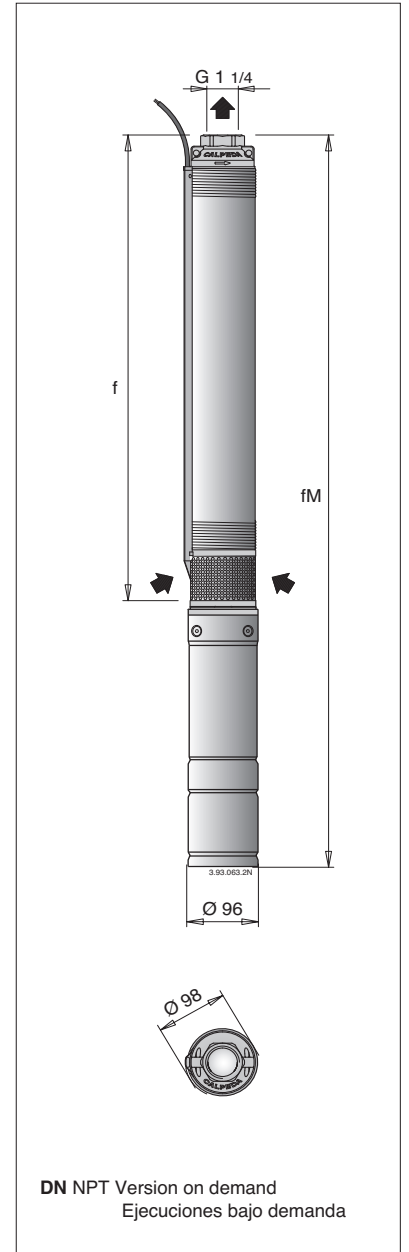
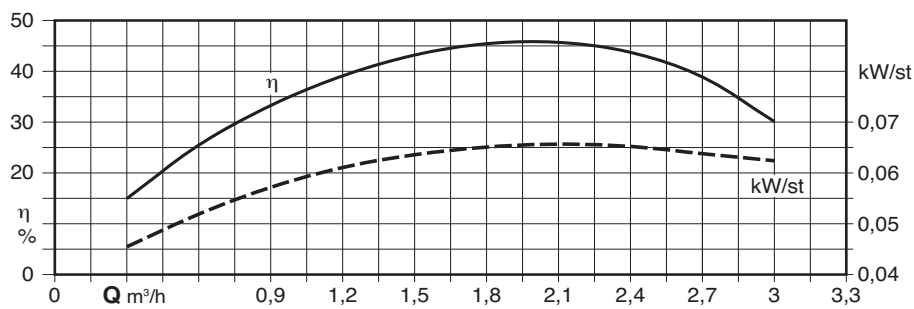
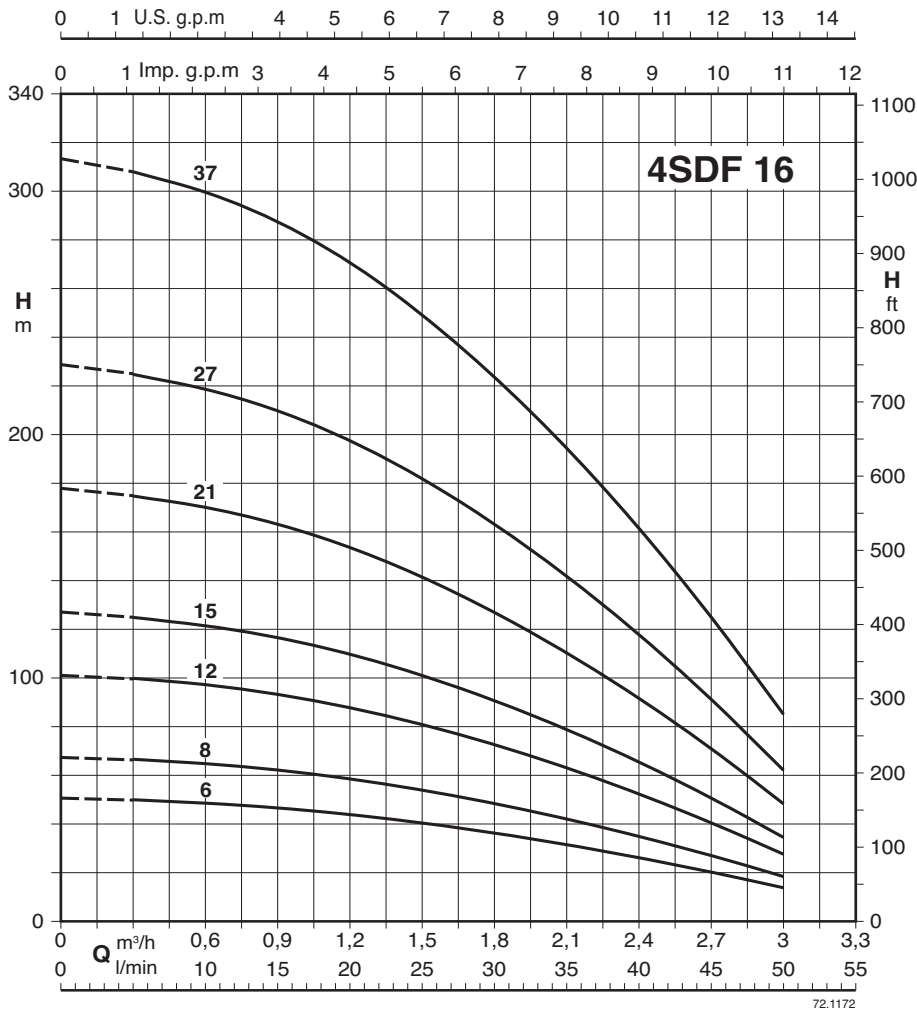

3~	1~	P ₂		Q	n ≈ 3450 1/min											4SDF		4SDFM		
					m³/h											f	fM	kg	fM	kg
						l/min	0	0,3	0,6	0,9	1,2	1,5	1,8	2,1	2,4	3	mm	mm		mm
		kW	HP		0	5	10	15	20	25	30	35	40	50						
				H m	50,9	49,9	48,6	46,6	43,9	40,4	36,3	31,5	26,2	13,8	305	632	11	632	10,9	
		0,37	0,5		67,8	66,6	64,8	62,2	58,5	53,9	48,3	42	34,9	18,4	345	672	11,3	672	11,2	
		0,55	0,75		102	99,9	97,2	93,2	87,8	80,8	72,5	63	52,4	27,6	425	772	13,1	787	13,8	
		0,75	1		127	125	121	117	110	101	90,6	78,8	65,5	34,5	485	847	14,8	887	15,6	
		1,1	1,5		178	175	170	163	154	141	127	110	91,7	48,3	605	1007	17,1	1052	18,4	
		1,5	2		229	225	219	210	198	182	163	142	118	62,1	725	1172	19,8	1192	20,7	
		2,2	3		314	308	300	287	271	249	224	194	161	85,1	915	1317	20,8	1432	24,8	

P₂ Rated motor power output.
Potencia nominal del motor.

H Total head in m
Altura total en m

Tolerances according to UNI EN ISO 9906:2012.
Tolerancias según UNI EN ISO 9906:2012.

4SDF 22 60 Hz



Performance - Prestaciones $n \approx 3450$ rpm, dimensions and weights - dimensiones y pesos

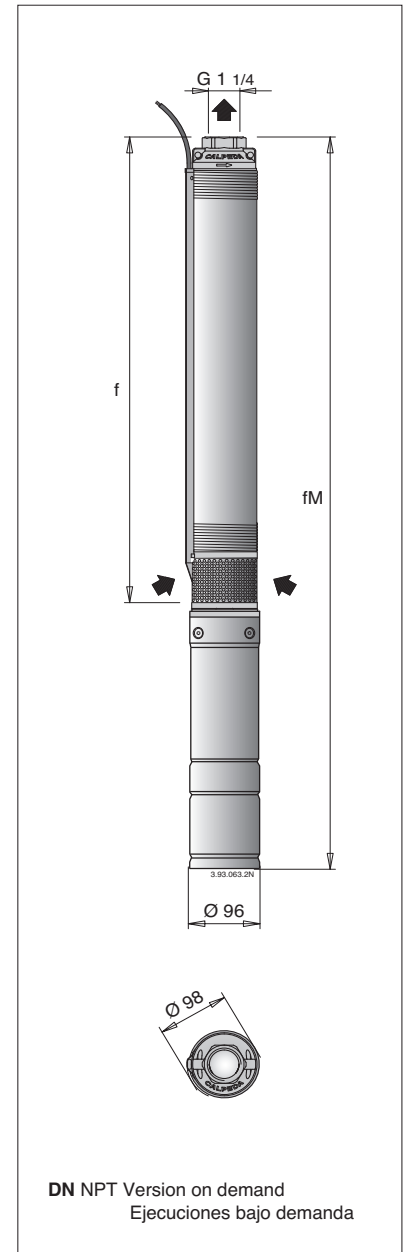
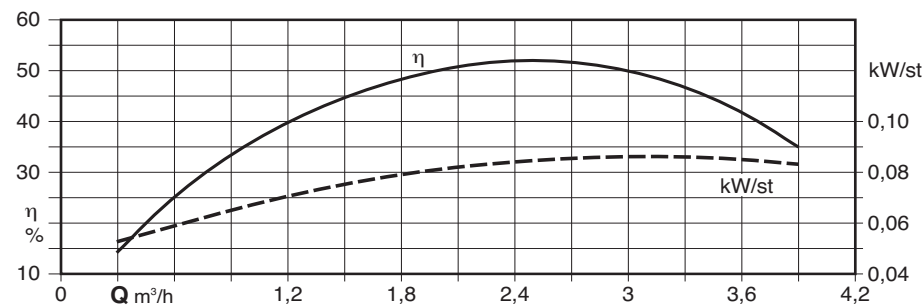
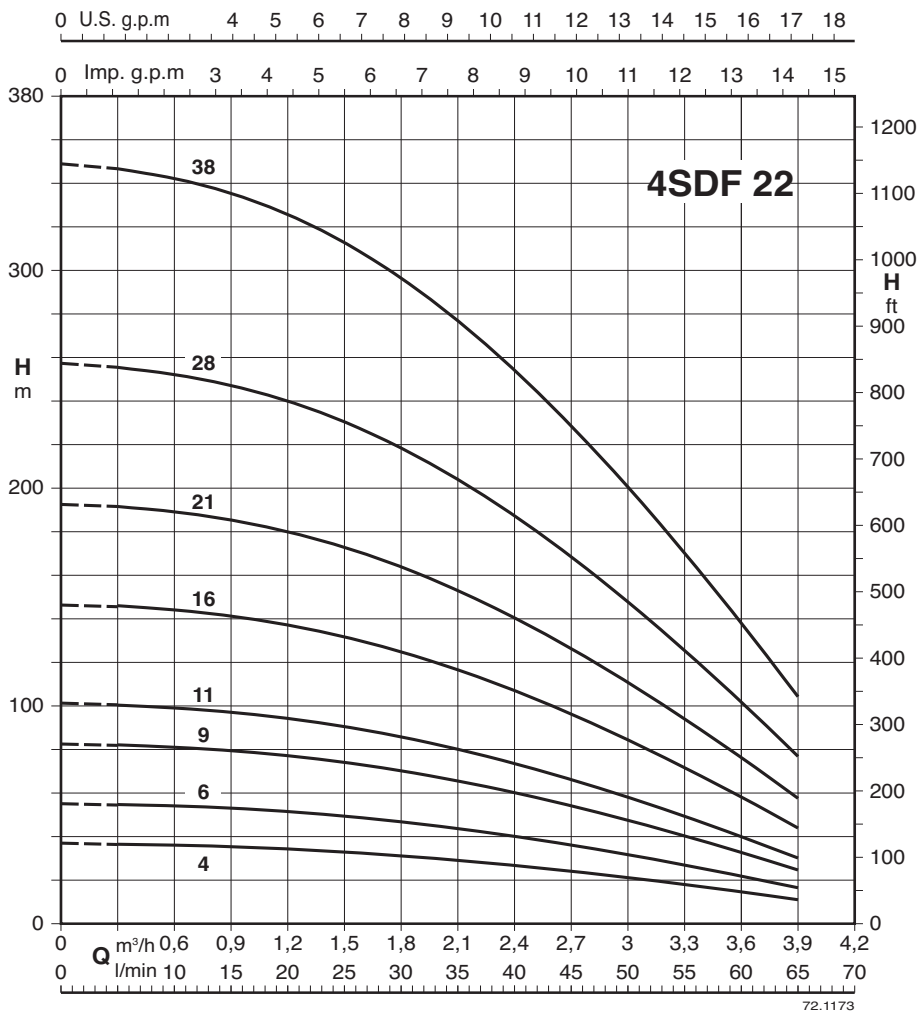

3~	1~	P ₂		Q	n ≈ 3450 1/min											4SDF		4SDFM						
					kW		HP		m ³ /h											f	fM	kg	fM	kg
					0	0,3	0,6	0,9	1,2	1,8	2,4	3	3,6	3,9	mm	mm	mm	mm						
4SDF 22/4EC-60	4SDFM 22/4EC-60	0,37	0,5	36,8	36,5	36	35,3	34,3	31,2	26,8	21,1	14,5	11	265	592	10,6	592	10,5						
4SDF 22/6EC-60	4SDFM 22/6EC-60	0,37	0,5	55,2	54,7	54	53	51,4	46,8	40,1	31,7	21,8	16,5	305	632	11	632	10,9						
4SDF 22/9EC-60	4SDFM 22/9EC-60	0,55	0,75	82,8	82,1	81,1	79,4	77,1	70,2	60,2	47,5	32,7	24,7	365	712	12,5	727	13,2						
4SDF 22/11EC-60	4SDFM 22/11EC-60	0,75	1	101	100	99,1	97,1	94,3	85,8	73,6	58	40	30,2	405	767	14,1	807	14,9						
4SDF 22/16EC-60	4SDFM 22/16EC-60	1,1	1,5	147	146	144	141	137	125	107	84,4	58,1	43,9	505	907	16,1	952	17,5						
4SDF 22/21EC-60	4SDFM 22/21EC-60	1,5	2	193	192	189	185	180	164	140	111	76,3	57,6	605	1052	18,6	1072	19,5						
4SDF 22/28EC-60	4SDFM 22/28EC-60	2,2	3	257	255	252	247	240	218	187	148	102	76,8	745	1147	19,1	1262	23,1						
4SDF 22/38EC-60		3	4	349	347	342	335	326	296	254	201	138	104	935	1408	24,3								

P₂ Rated motor power output.
Potencia nominal del motor.

H Total head in m
Altura total en m

Tolerances according to UNI EN ISO 9906:2012.
Tolerancias según UNI EN ISO 9906:2012.

4SDF 36 60 Hz



Performance - Prestaciones $n \approx 3450$ rpm, dimensions and weights - dimensiones y pesos

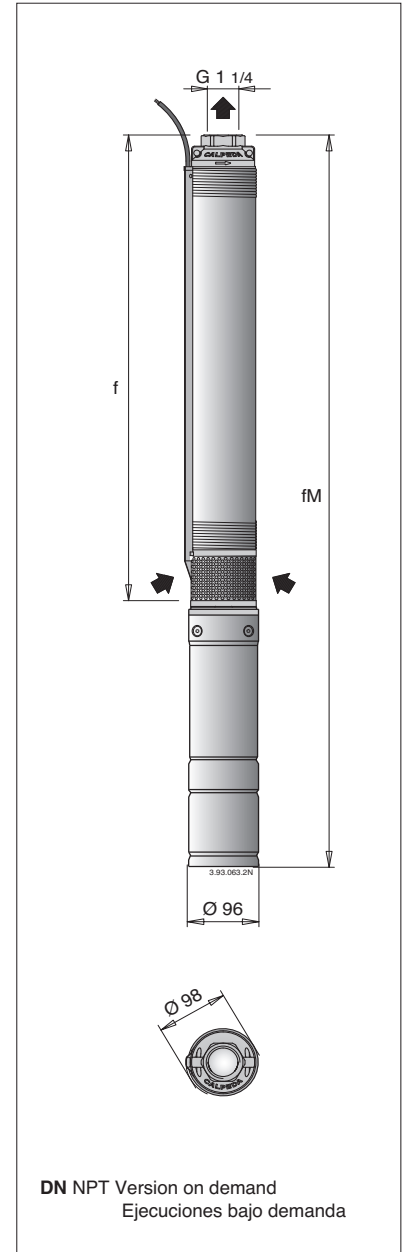
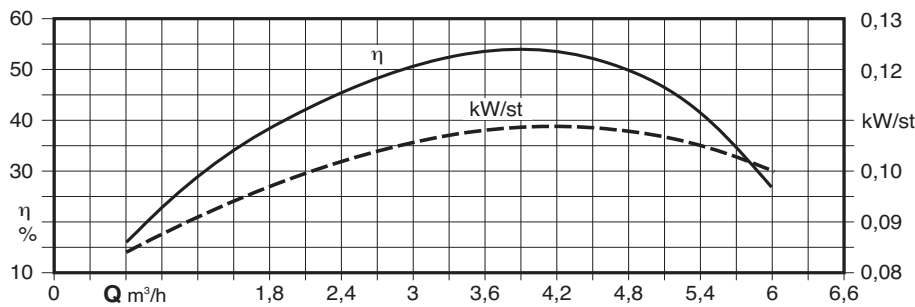
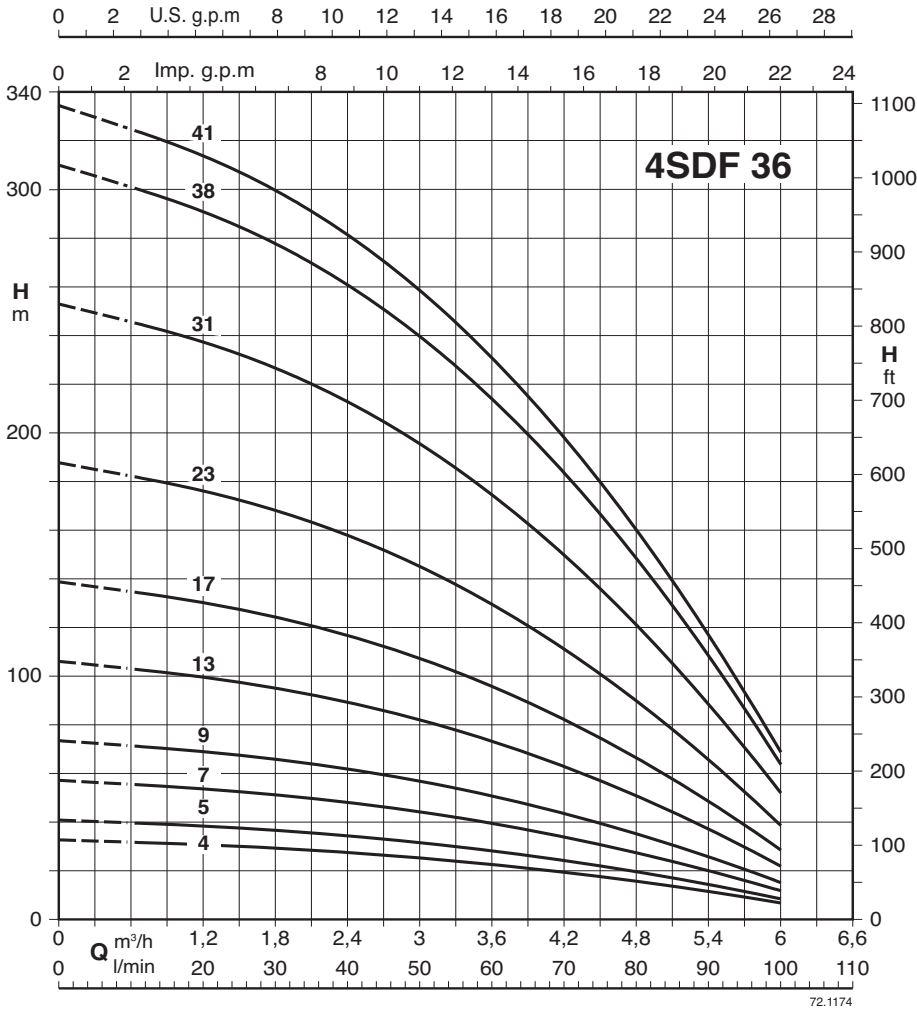

3~	1~	P ₂		Q	n ≈ 3450 1/min											4SDF		4SDFM		
					m³/h	Q											f	fM	f	fM
						l/min	0	0,6	1,2	1,8	2,4	3	3,6	4,2	4,8	6	mm	mm	mm	mm
		kW	HP		0	10	20	30	40	50	60	70	80	100	kg	kg				
				H																
				m																
4SDF 36/4EC-60	4SDFM 36/4EC-60	0,37	0,5		32,6	31,7	30,6	29,2	27,4	25,2	22,5	19,3	15,6	6,7	290	617	10,7	617	10,6	
4SDF 36/5EC-60	4SDFM 36/5EC-60	0,37	0,5		40,8	39,6	38,3	36,5	34,3	31,5	28,1	24,1	19,5	8,4	317	644	11	644	10,9	
4SDF 36/7EC-60	4SDFM 36/7EC-60	0,55	0,75		57,1	55,4	53,6	51,1	48,0	44,1	39,4	33,8	27,3	11,7	370	717	12,5	717	13,2	
4SDF 36/9EC-60	4SDFM 36/9EC-60	0,75	1		73,4	71,3	68,9	65,7	61,7	56,7	50,6	43,4	35,1	15,1	422	784	14,1	799	14,9	
4SDF 36/13EC-60	4SDFM 36/13EC-60	1,1	1,5		106	103	99,5	95,0	89,2	81,9	73,1	62,7	50,7	21,8	528	930	16,1	935	17,5	
4SDF 36/17EC-60	4SDFM 36/17EC-60	1,5	2		139	135	130	124	117	107	95,6	82,0	66,3	28,4	635	1082	18,7	1102	19,7	
4SDF 36/23EC-60	4SDFM 36/23EC-60	2,2	3		188	182	176	168	158	145	129	111	89,7	38,5	794	1196	19,1	1311	23,1	
4SDF 36/31EC-60		3	4		253	245	237	226	213	195	174	150	121	51,9	979	1452	24,5			
4SDF 36/38EC-60		4	5,5		310	301	291	278	261	239	214	183	148	63,6	1165	1703	26,8			
4SDF 36/41EC-60		4	5,5		334	325	314	300	281	258	231	198	160	68,6	1244	1782	27,1			

P₂ Rated motor power output.
Potencia nominal del motor.

H Total head in m
Altura total en m

Tolerances according to UNI EN ISO 9906:2012.
Tolerancias según UNI EN ISO 9906:2012.

4SDF 46 60 Hz



Performance - Prestaciones $n \approx 3450$ rpm, dimensions and weights - dimensiones y pesos

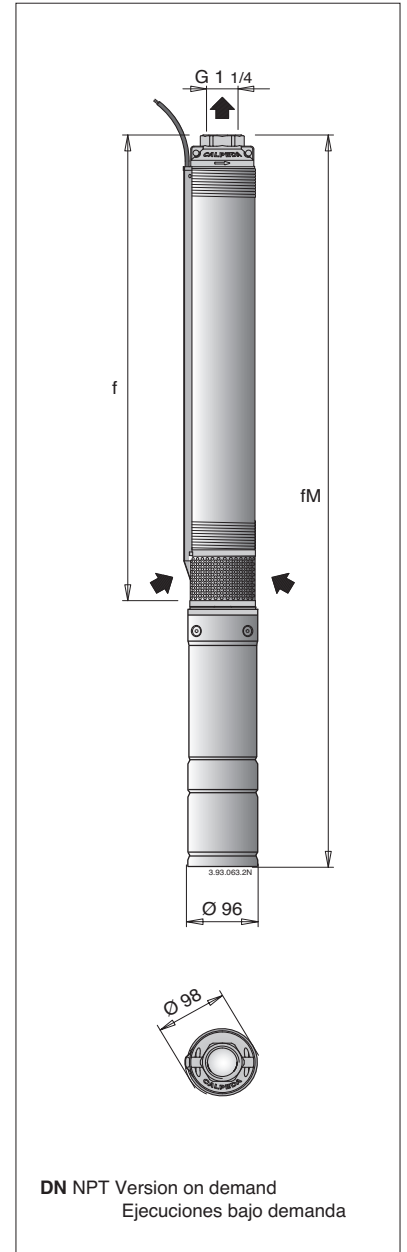
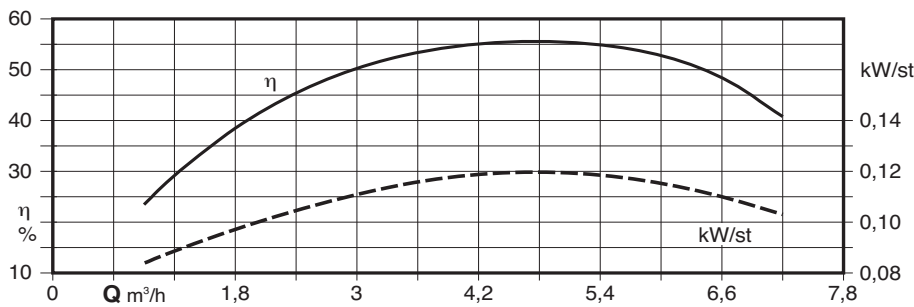
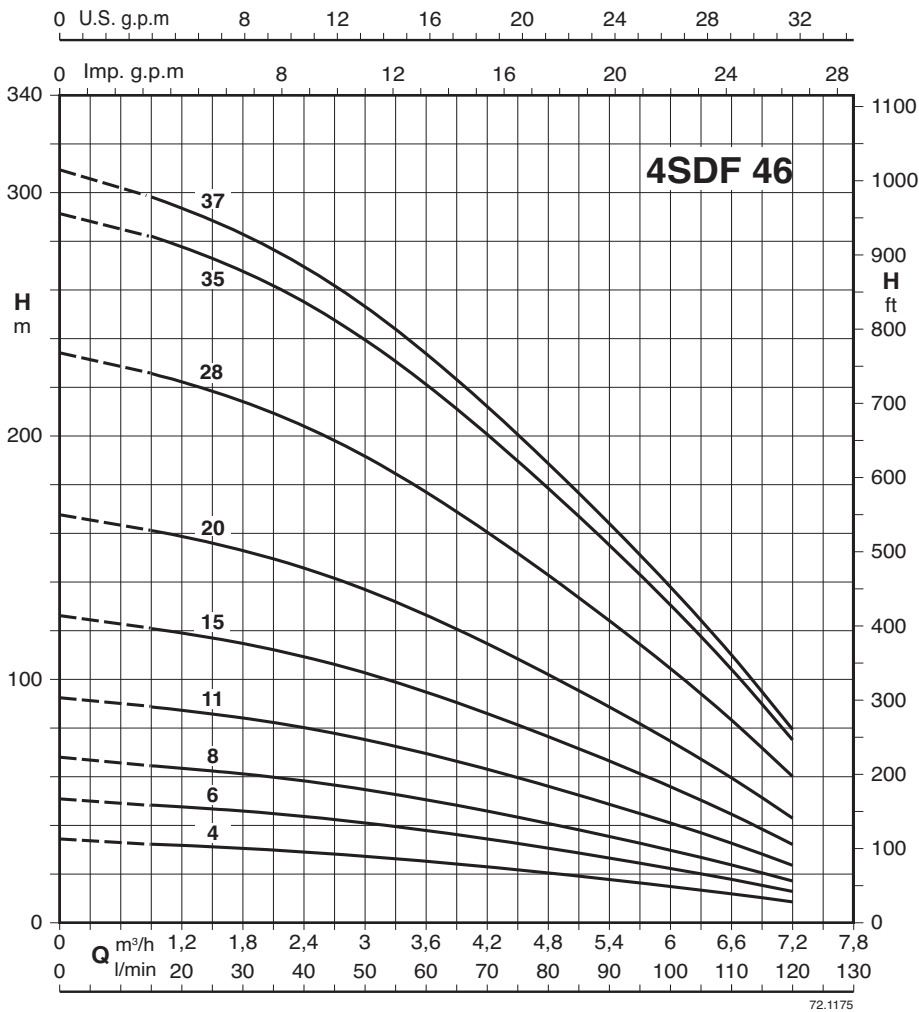

3~	1~	P ₂		Q	n \approx 3450 1/min											4SDF		4SDFM		
					m ³ /h											f	fM	kg	fM	kg
					0	0,9	1,2	1,8	2,4	3	3,6	4,8	6	7,2	mm	mm		mm	kg	
		kW	HP	l/min	0	15	20	30	40	50	60	80	100	120						
				H																
				m																
4SDF 46/4EC-60	4SDFM 46/4EC-60	0,37	0,5		33,6	32,2	31,7	30,6	29,1	27,4	25,3	20,4	14,9	8,6	290	617	9,7	617	9,6	
4SDF 46/6EC-60	4SDFM 46/6EC-60	0,55	0,75		50,3	48,4	47,6	45,9	43,7	41,1	37,9	30,6	22,4	12,9	340	687	12,1	702	12,8	
4SDF 46/8EC-60	4SDFM 46/8EC-60	0,75	1		67,1	64,5	63,5	61,2	58,3	54,7	50,6	40,8	29,8	17,2	395	757	13,8	797	14,5	
4SDF 46/11EC-60	4SDFM 46/11EC-60	1,1	1,5		92,3	88,6	87,3	84,1	80,2	75,3	69,5	56,1	41	23,6	475	877	15,5	922	16,9	
4SDF 46/15EC-60	4SDFM 46/15EC-60	1,5	2		126	121	119	115	109	103	94,8	76,5	55,9	32,2	585	1032	18	1052	18,9	
4SDF 46/20EC-60	4SDFM 46/20EC-60	2,2	3		168	161	159	153	146	137	126	102	74,6	42,9	715	1117	18,2	1232	22,2	
4SDF 46/28EC-60		3	4		235	226	222	214	204	192	177	143	104	60,1	925	1398	23,2			
4SDF 46/35EC-60		4	5,5		294	282	278	268	255	239	221	178	131	75,1	1110	1648	27,9			
4SDF 46/37EC-60		4	5,5		310	298	294	283	270	253	234	189	138	79,4	1165	1703	28,4			

P₂ Rated motor power output.
Potencia nominal del motor.

H Total head in m
Altura total en m

Tolerances according to UNI EN ISO 9906:2012.
Tolerancias según UNI EN ISO 9906:2012.

4SDF 54 60 Hz



Performance - Prestaciones $n \approx 3450$ rpm, dimensions and weights - dimensiones y pesos

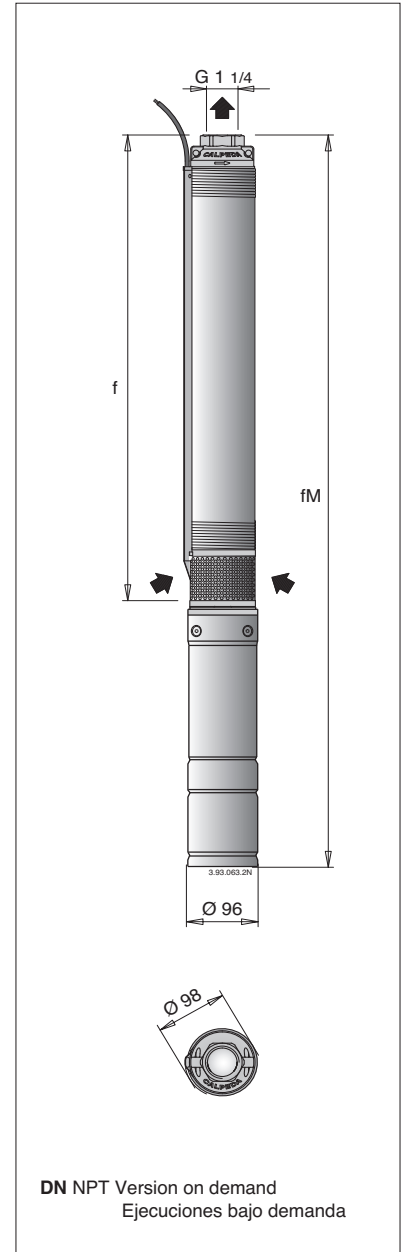
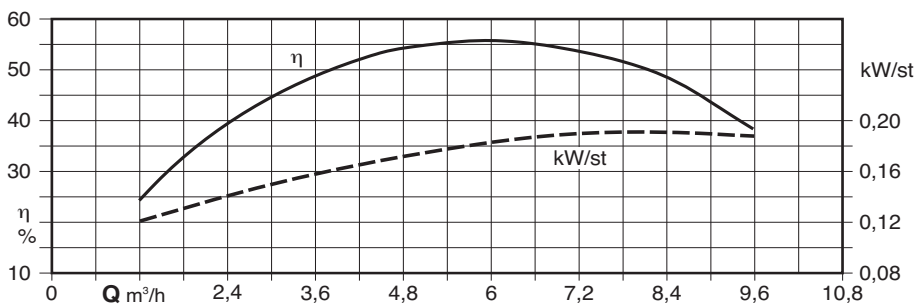
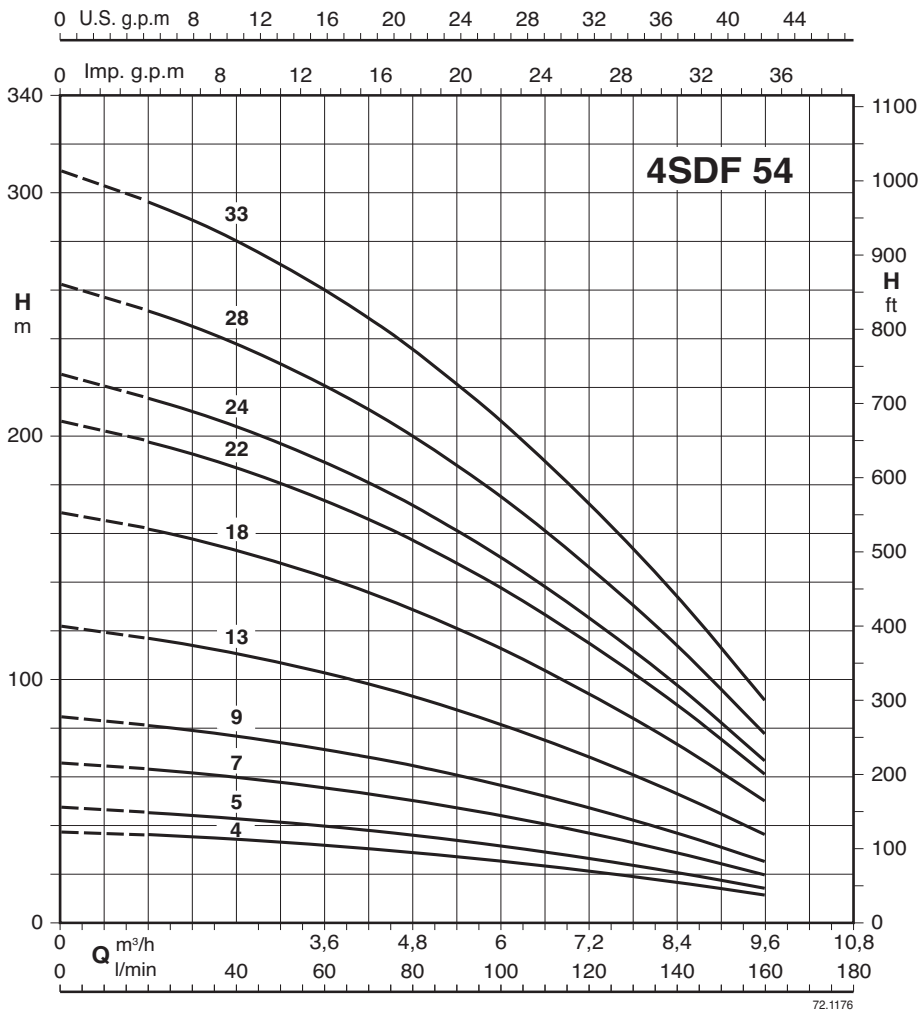

3~	1~	P ₂		Q	n ≈ 3450 1/min											4SDF		4SDFM	
		kW	HP		m ³ /h	0	1,2	2,4	3,6	4,2	4,8	6	7,2	8,4	9,6	f	fM	kg	fM
				l/min	0	20	40	60	70	80	100	120	140	160	mm	mm		mm	
4SDF 54/4EC-60	4SDFM 54/4EC-60	0,55	0,75	H	37,4	35,9	34,0	31,5	30,1	28,6	25,0	20,9	16,3	11,0	310	657	11,6	672	12,4
4SDF 54/5EC-60	4SDFM 54/5EC-60	0,75	1		46,7	44,9	42,5	39,4	37,6	35,7	31,3	26,1	20,3	13,8	340	702	13	742	13,8
4SDF 54/7EC-60	4SDFM 54/7EC-60	1,1	1,5		65,4	62,8	59,4	55,2	52,7	50,0	43,8	36,5	28,5	19,3	400	802	14,6	847	16
4SDF 54/9EC-60	4SDFM 54/9EC-60	1,5	2		84,1	80,8	76,4	70,9	67,8	64,3	56,3	47,0	36,6	24,9	460	907	16,7	927	17,6
4SDF 54/13EC-60	4SDFM 54/13EC-60	2,2	3		122	117	110	102	97,9	92,8	81,3	67,8	52,9	35,9	580	982	16,7	1097	20,8
4SDF 54/18EC-60		3	4		168	162	153	142	136	129	113	93,9	73,2	49,7	730	1203	21,1		
4SDF 54/22EC-60		4	5,5		206	198	187	173	166	157	138	115	89,5	60,8	850	1388	25,4		
4SDF 54/24EC-60		4	5,5		224	215	204	189	181	171	150	125	97,6	66,3	910	1448	25,8		
4SDF 54/28EC-60		5,5	7,5		262	251	238	221	211	200	175	146	114	77,3	1030	1668	31,2		
4SDF 54/33EC-60		5,5	7,5		309	296	280	260	249	236	206	172	134	91,1	1180	1818	32,5		

P₂ Rated motor power output.
Potencia nominal del motor.

H Total head in m
Altura total en m

Tolerances according to UNI EN ISO 9906:2012.
Tolerancias según UNI EN ISO 9906:2012.

4SD 10 60 Hz



Performance - Prestaciones $n \approx 3450$ rpm, dimensions and weights - dimensiones y pesos

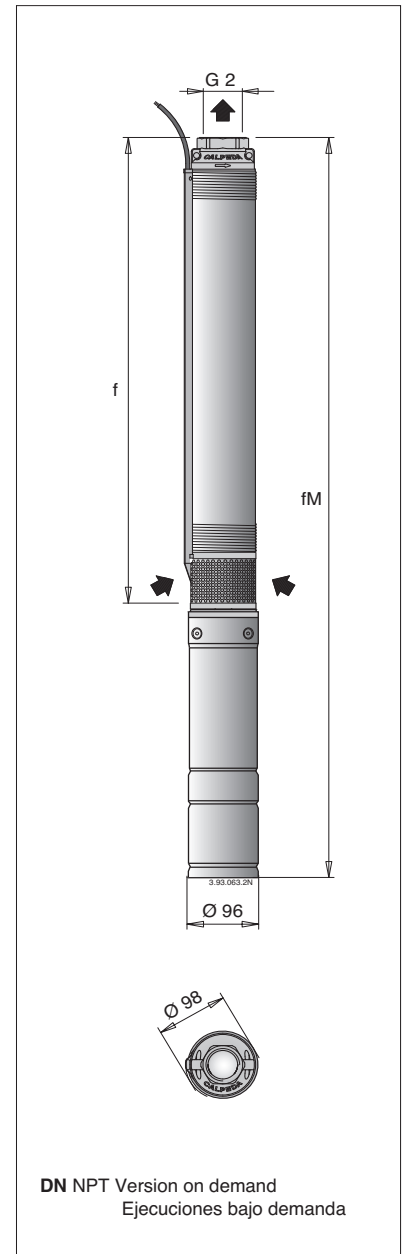
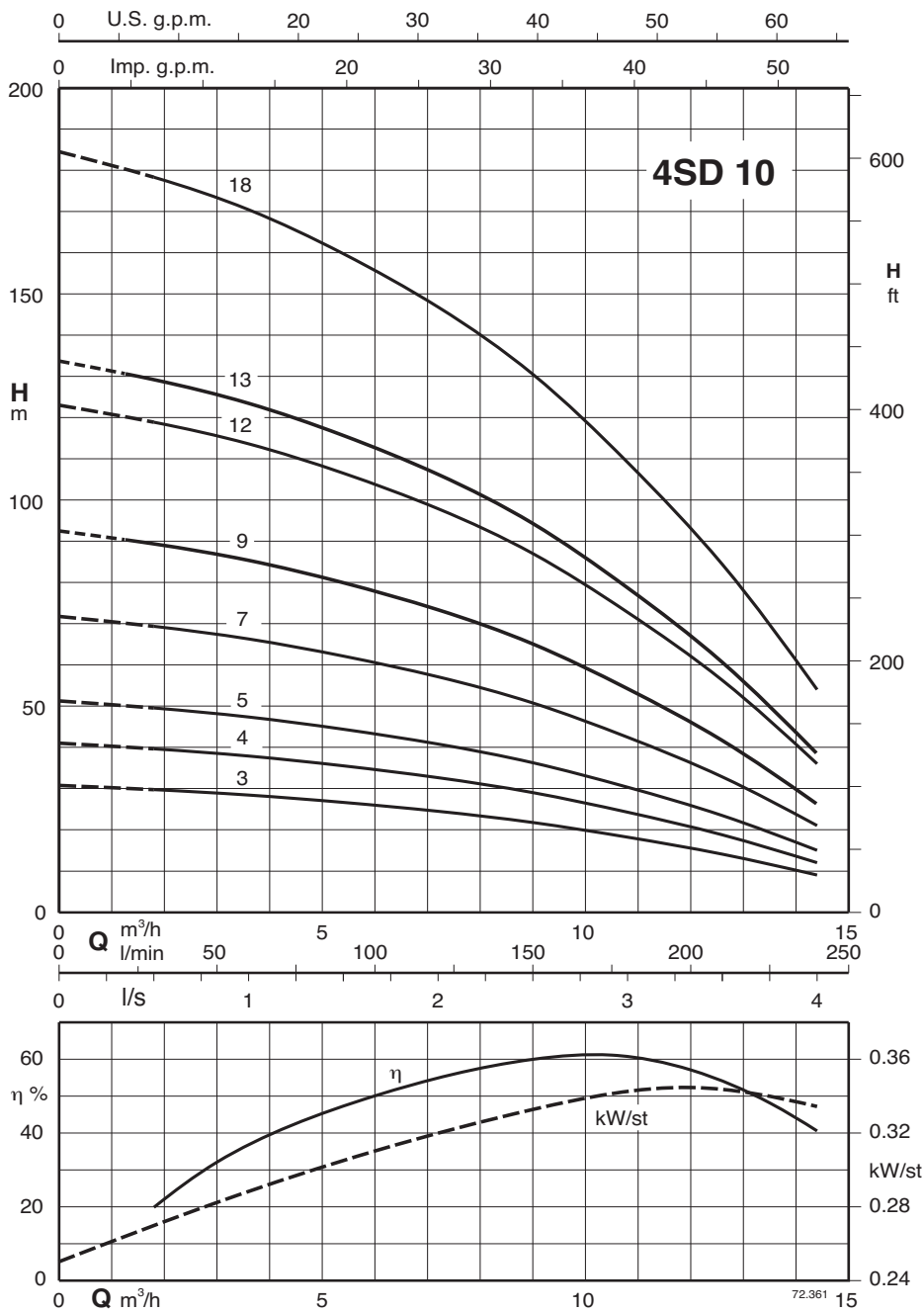

3~	1~	P ₂		Q	n ≈ 3450 1/min											4SD		4SDM	
		kW	HP		0	1,2	2,4	3,6	6	8,4	10,8	12	13,2	14,4	f	fM	fM	fM	
				m³/h	0	20	40	60	100	140	180	200	220	240	mm	mm	kg	mm	kg
4SD 10/3EC-60	4SDM 10/3EC-60	0,75	1	H	31	30	29	28	26	23	18	18	12	9	427	789	12,2	829	13,2
4SD 10/4EC-60	4SDM 10/4EC-60	1,1	1,5		41	40	39	38	34	30	24	24	16	12	480	882	13,9	927	14,5
4SD 10/5EC-60	4SDM 10/5EC-60	1,5	2		51	50	49	47	43	38	30	30	20	15	533	980	15,2	1000	15,3
4SD 10/7EC-60	4SDM 10/7EC-60	2,2	3		72	70	69	66	61	53	43	43	29	21	638	1040	13,6	1155	19,4
4SD 10/9EC-60		3	4		92	90	89	85	78	68	55	55	36	27	715	1188	23,6		
4SD 10/12EC-60		4	5,5		123	120	118	113	104	91	73	73	48	36	902	1440	25,2		
4SD 10/13EC-60		4	5,5		133	130	128	122	113	99	79	79	52	39	925	1463	31,1		
4SD 10/18EC-60		5,5	7,5		184	180	177	171	156	136	110	110	75	54	1220	1858	32,5		

P₂ Rated motor power output.
Potencia nominal del motor.

H Total head in m
Altura total en m

Tolerances according to UNI EN ISO 9906:2012.
Tolerancias según UNI EN ISO 9906:2012.

4SD 15 60 Hz



Performance - Prestaciones $n \approx 3450$ rpm, dimensions and weights - dimensiones y pesos

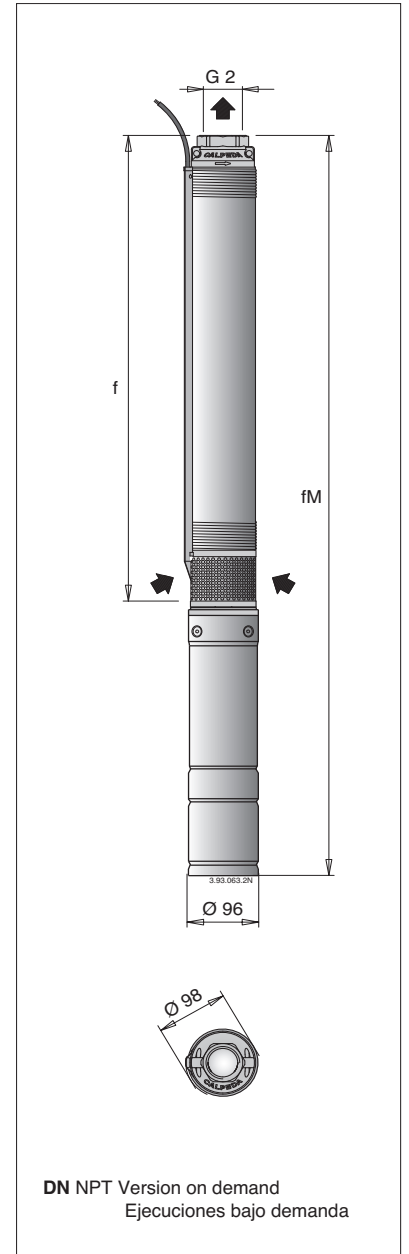
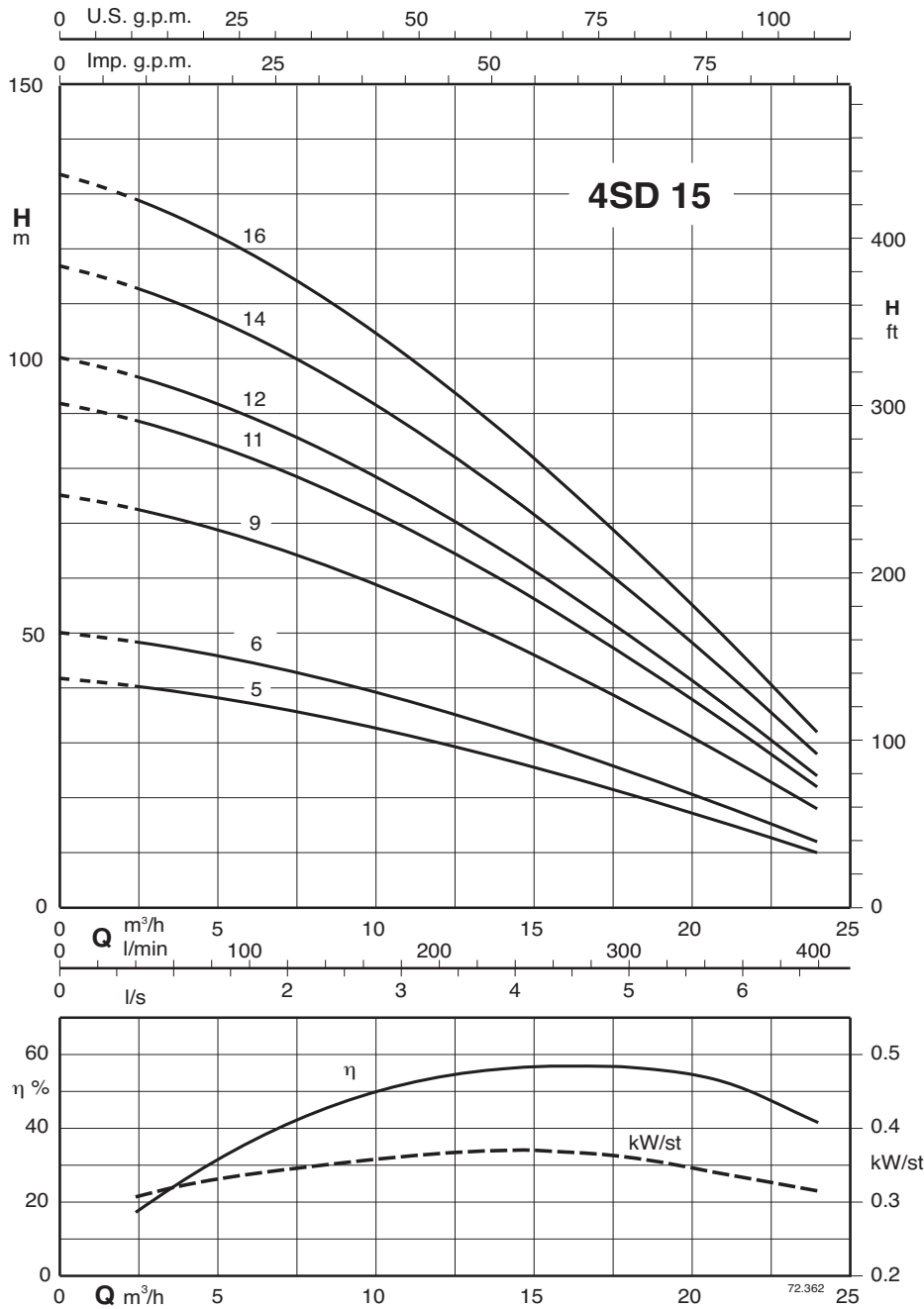

3~	1~	P2		Q	n ≈ 3450 1/min										4SD		4SDM							
					kW		HP		m³/h		l/min		m		f	fM	kg	fM	kg					
					0	2,4	4,8	7,2	9,6	12	15	18	21	24	0	40	80	120	160	200	250	300	350	400
4SD 15/5EC-60	4SDM 15/5EC-60	1,5	2	H	41,8	40,4	38,5	36,1	33,3	30,1	25,7	20,8	15,5	10	600	1047	17,1	1067	18					
4SD 15/6EC-60	4SDM 15/6EC-60	2,2	3		50,2	48,5	46,2	43,3	39,9	36,1	30,8	24,9	18,6	12	680	1082	16,9	1197	20,9					
4SD 15/9EC-60		3	4		75,3	72,7	69,2	65	59,9	54,2	46,2	37,4	28	18	915	1388	22,4							
4SD 15/11EC-60		4	5,5		92	88,9	84,6	79,4	73,2	66,2	56,4	45,7	34,2	22	1070	1608	26,8							
4SD 15/12EC-60		4	5,5		100	96,9	92,3	86,6	79,9	72,2	61,6	49,9	37,3	24	1145	1683	27,4							
4SD 15/14EC-60		5,5	7,5		117	113	108	101	93,2	84,3	71,8	58,2	43,5	28	1375	2013	32,9							
4SD 15/16EC-60		5,5	7,5		134	129	123	116	107	96,3	82,1	66,5	49,7	32	1520	2158	34,3							

P2 Rated motor power output.
Potencia nominal del motor.

H Total head in m
Altura total en m

Tolerances according to UNI EN ISO 9906:2012.
Tolerancias según UNI EN ISO 9906:2012.

6SDN 12 60 Hz



Performance - Prestaciones $n \approx 3450$ rpm, dimensions and weights - dimensiones y pesos

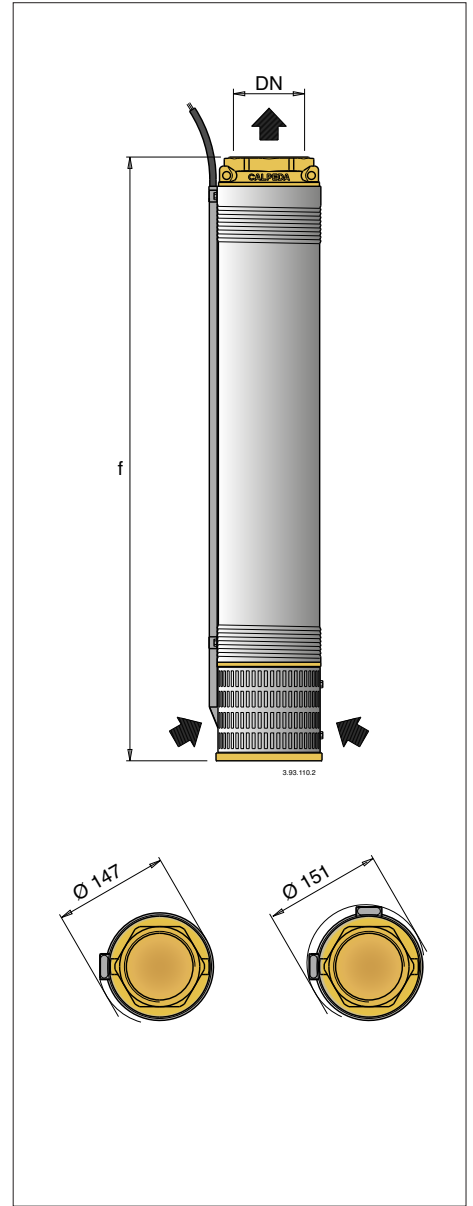
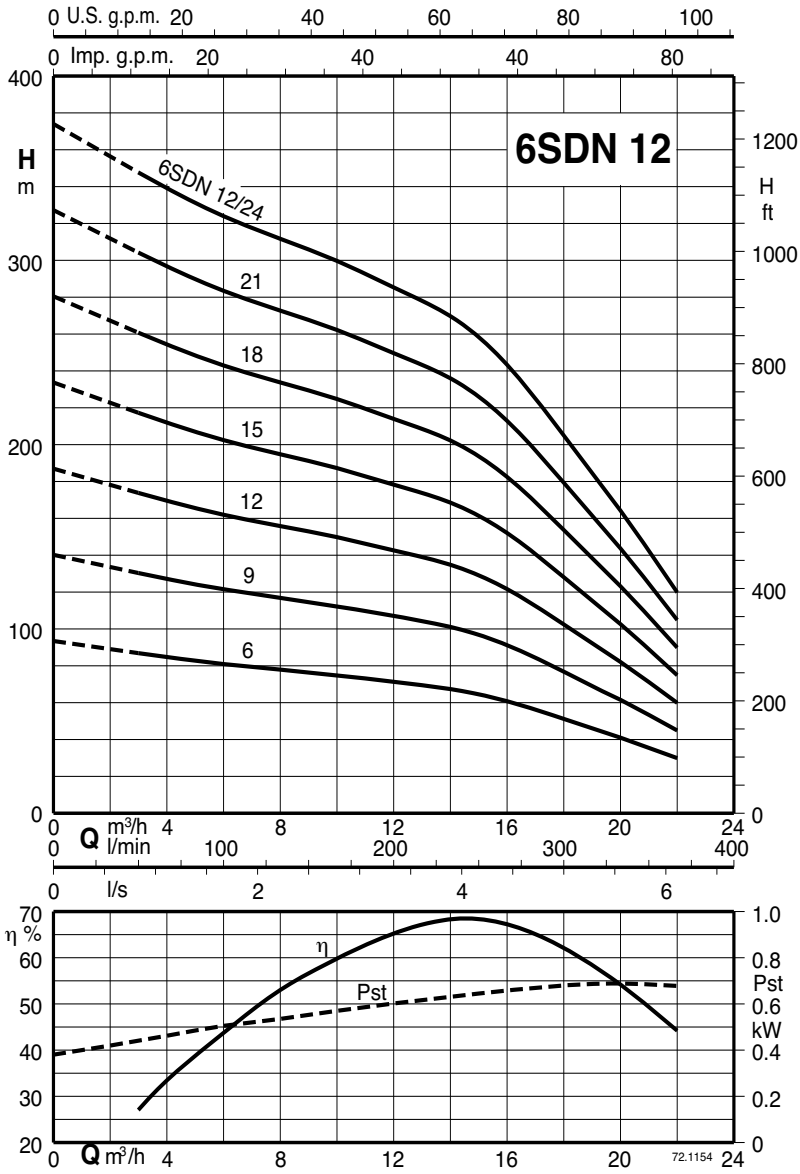

3 ~	P2		Q	$n \approx 3450$ rpm										
	kW	HP		H										
				3	6	8	10	12	14	16	18	20	22	
6SDN 12/6-60	4	5,5	87	81	78	75	71,5	67,5	60	51,5	41	30		
6SDN 12/9-60	5,5	7,5	131	122	117	113	107	101	91	77	61,5	45		
6SDN 12/12-60	7,5	10	174	162	156	150	143	135	122	103	82	60		
6SDN 12/15-60	9,2	12,5	218	203	195	188	179	169	152	128	103	75		
6SDN 12/18-60	11	15	261	243	234	225	214	203	183	154	123	90		
6SDN 12/21-60	13	17,5	305	284	273	263	250	236	213	180	144	105		
6SDN 12/24-60	15	20	348	324	312	300	286	270	244	205	165	120		

DN	f	
	mm	kg
G 3 ISO 228	560	12,8
	677	14,5
	793	16,2
	908	17,9
	1025	19,6
	1141	21,3
	1320	23

P2 Rated motor power output.
Potencia nominal del motor.

H Total head in m
Altura total en m

Tolerances according to UNI EN ISO 9906:2012.
Tolerancias según UNI EN ISO 9906:2012.

6SDN 16 60 Hz



Performance - Prestaciones $n \approx 3450$ rpm, dimensions and weights - dimensiones y pesos

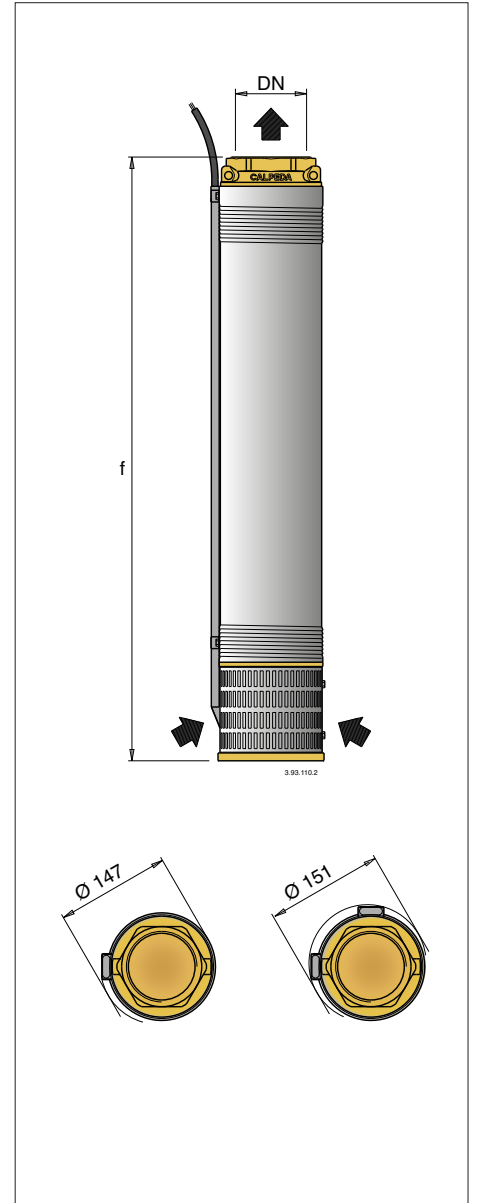
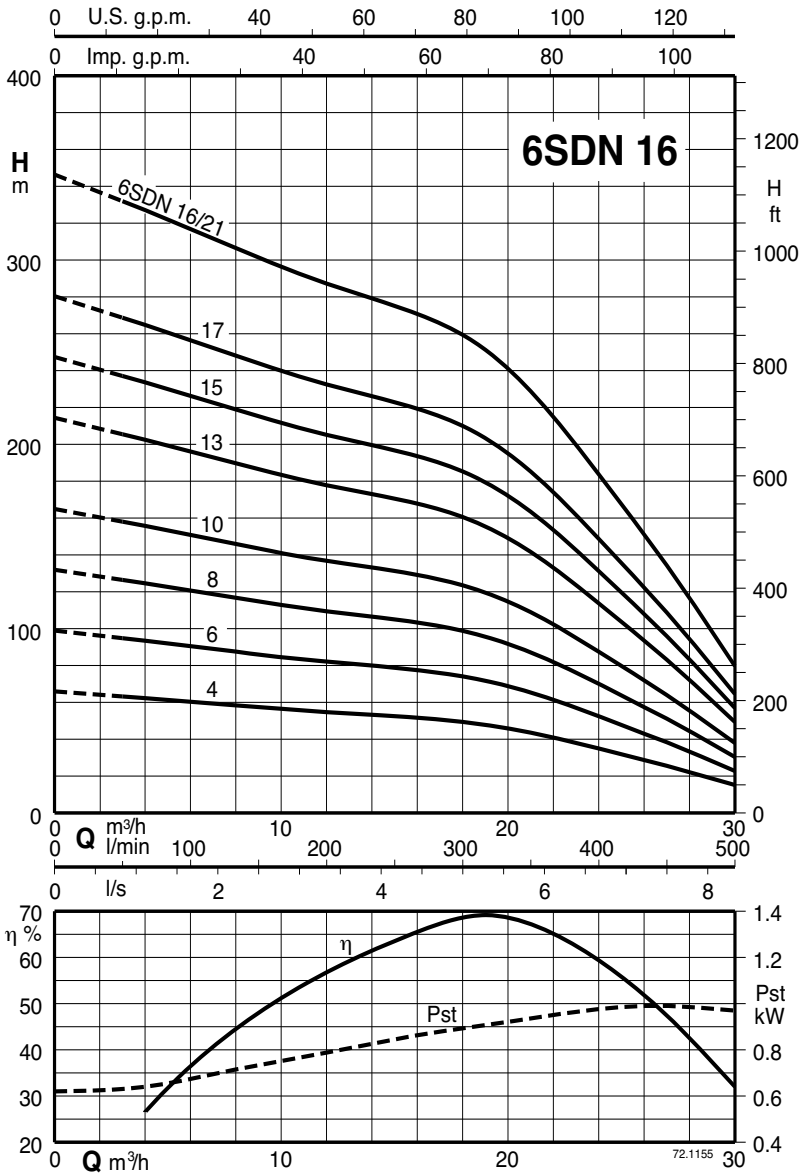

3 ~	P ₂		Q	n ≈ 3450 rpm											
	kW	HP	m ³ /h	4	8	12	15	18	21	24	27	30			
			l/min	66,6	133,3	200	250	300	350	400	450	500			
		H m		62,5	58,5	54,7	52	50	43,5	35	25,5	15			
6SDN 16/4-60	4		5,5	93,5	87,5	82	78	75	65,5	52,5	38,5	23			
6SDN 16/6-60	5,5		7,5	125	117	109	104	100	87	70	51	30,5			
6SDN 16/8-60	7,5		10	156	146	137	130	125	109	87,5	64	38			
6SDN 16/10-60	9,2		12,5	203	190	178	169	163	142	114	83	49,5			
6SDN 16/13-60	11		15	234	219	205	195	188	164	131	96	57			
6SDN 16/15-60	13		17,5	265	248	233	221	213	185	149	109	64,5			
6SDN 16/17-60	15		20	327	307	287	273	263	229	184	134	80			
6SDN 16/21-60	18,5	25													

DN	f	
	mm	kg
G 3 ISO 228	484	12,5
	561	13,5
	638	14,5
	715	15,5
	830	17
	907	18
	985	19
	1139	21,5

P₂ Rated motor power output.
Potencia nominal del motor.

H Total head in m
Altura total en m

Tolerances according to UNI EN ISO 9906:2012.
Tolerancias según UNI EN ISO 9906:2012.

6SDN 21 60 Hz



Performance - Prestaciones $n \approx 3450$ rpm, dimensions and weights - dimensiones y pesos

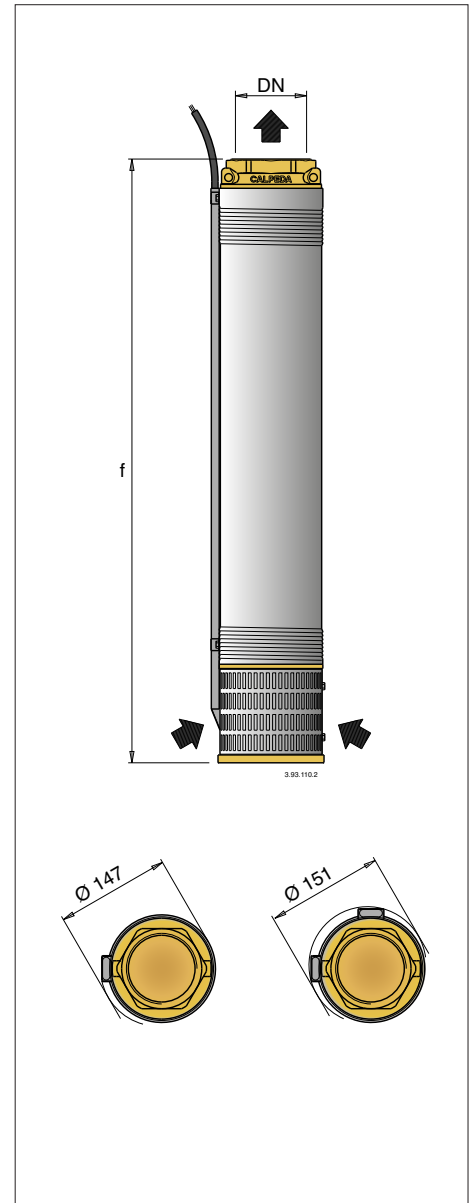
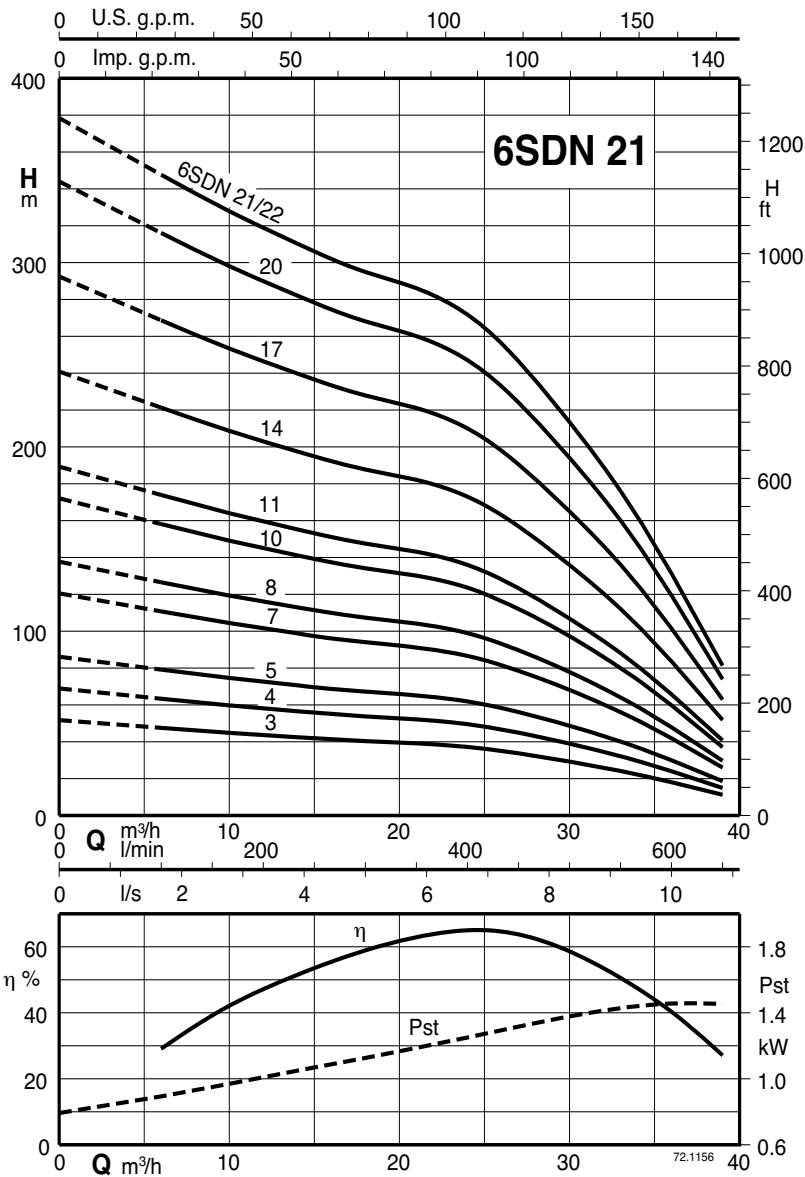

3 ~	P ₂		Q	$n \approx 3450$ rpm											
				H											
	kW	HP		m³/h	6	10	14	18	21	24	27	30	33	36	39
6SDN 21/3-60	4	5,5	47,5	44,5	42,5	40	39	37	33,5	29	24	18	11		
6SDN 21/4-60	5,5	7,5	63	59,5	56,5	53,5	52	49,5	45	39	32	24	15		
6SDN 21/5-60	7,5	10	79	74,5	70,5	67	65	62	56	48,5	40	30	18,5		
6SDN 21/7-60	9,2	12,5	111	104	98,5	94	91	86,5	78,5	68	56	42	26		
6SDN 21/8-60	11	15	126	119	113	107	104	99	89,5	77,5	64	47,5	29,5		
6SDN 21/10-60	13	17,5	158	149	141	134	130	124	112	97	80	59,5	37		
6SDN 21/11-60	15	20	174	164	155	147	143	136	123	107	88	65,5	40,5		
6SDN 21/14-60	18,5	25	221	209	197	188	182	173	157	136	112	83,5	51,5		
6SDN 21/17-60	22	30	269	253	240	228	221	210	190	165	136	101	62,5		
6SDN 21/20-60	26	35	316	298	282	268	260	247	224	194	160	119	74		
6SDN 21/22-60	30	40	348	328	310	295	286	272	246	213	176	131	81		

DN	f	
	mm	kg
G 3 ISO 228	470	12,1
	517	12,7
	565	13,3
	660	14,5
	707	15,1
	802	16,3
	850	16,9
	992	18,7
	1135	20,5
	12771	22,3
1420	23,5	

P₂ Rated motor power output.
Potencia nominal del motor.

H Total head in m
Altura total en m

Tolerances according to UNI EN ISO 9906:2012.
Tolerancias según UNI EN ISO 9906:2012.

6SD 18 60 Hz



Performance - Prestaciones $n \approx 3450$ rpm, dimensions and weights - dimensiones y pesos

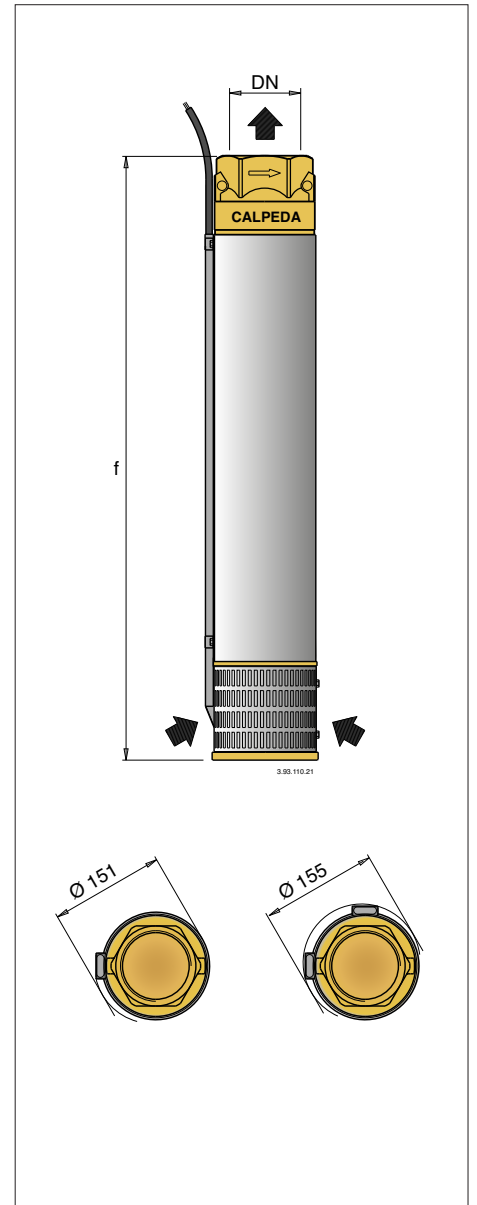
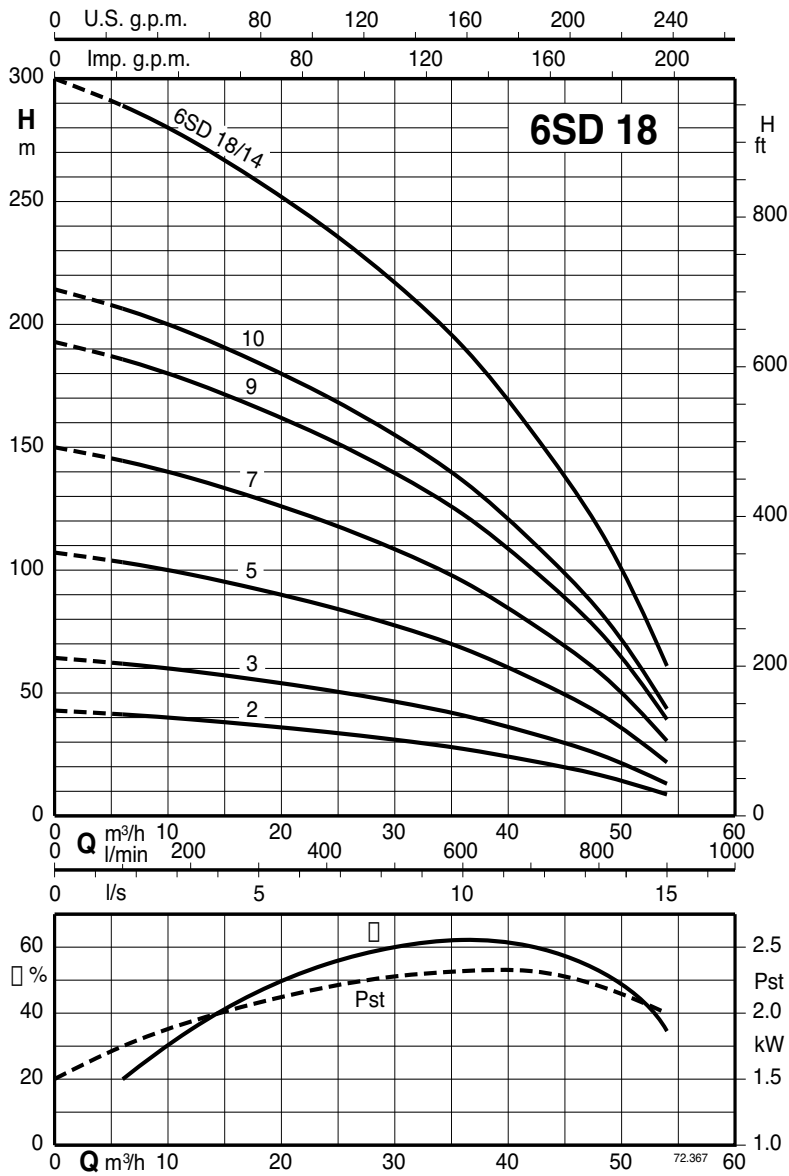

3 ~	P ₂		Q	$n \approx 3450$ rpm										
				m ³ /h										
	kW	HP		6	12	18	24	30	36	42	48	54		
6SD 18/2-60	5,5	7,5	42	40	39	35	33	27	23	16	8			
6SD 18/3-60	7,5	10	63	60	57	52	47	41	33	23	13			
6SD 18/5-60	11	15	105	100	94	87	79	68	56	40	21			
6SD 18/7-60	15	20	147	140	131	121	109	95	78	57	30			
6SD 18/9-60	18,5	25	188	179	167	153	137	118	95	69	39			
6SD 18/10-60	22	30	210	200	186	173	156	136	112	83	43			
6SD 18/14-60	30	40	291	277	260	240	218	191	158	117	61			

DN	f	
	mm	kg
G 3 ISO 228	542	58,5
	651	64,5
	870	74
	1088	86
	1307	103
	1416	121
	1853	146

P₂ Rated motor power output.
Potencia nominal del motor.

H Total head in m
Altura total en m

Tolerances according to UNI EN ISO 9906:2012.
Tolerancias según UNI EN ISO 9906:2012.

6SD 19 60 Hz



Performance - Prestaciones $n \approx 3450$ rpm, dimensions and weights - dimensiones y pesos

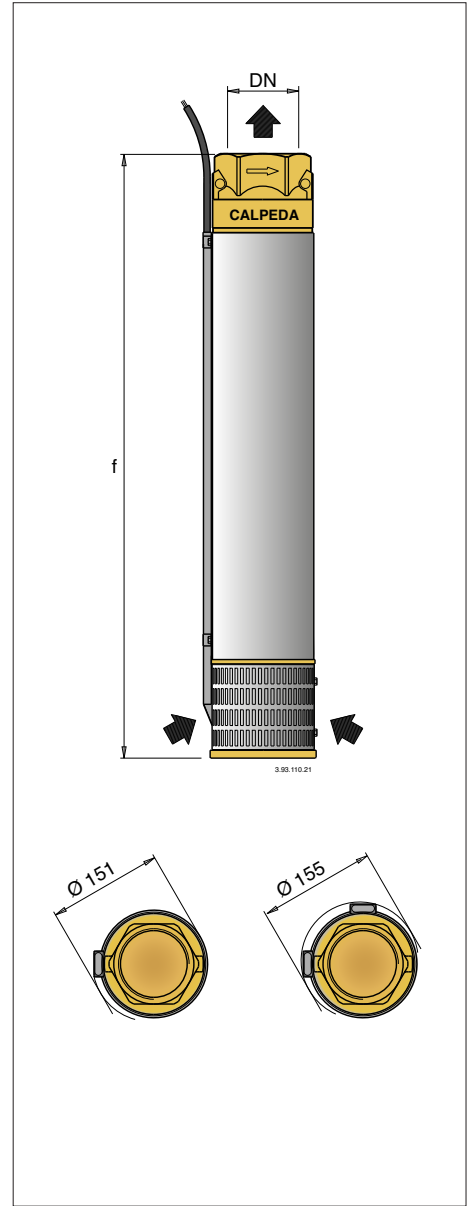
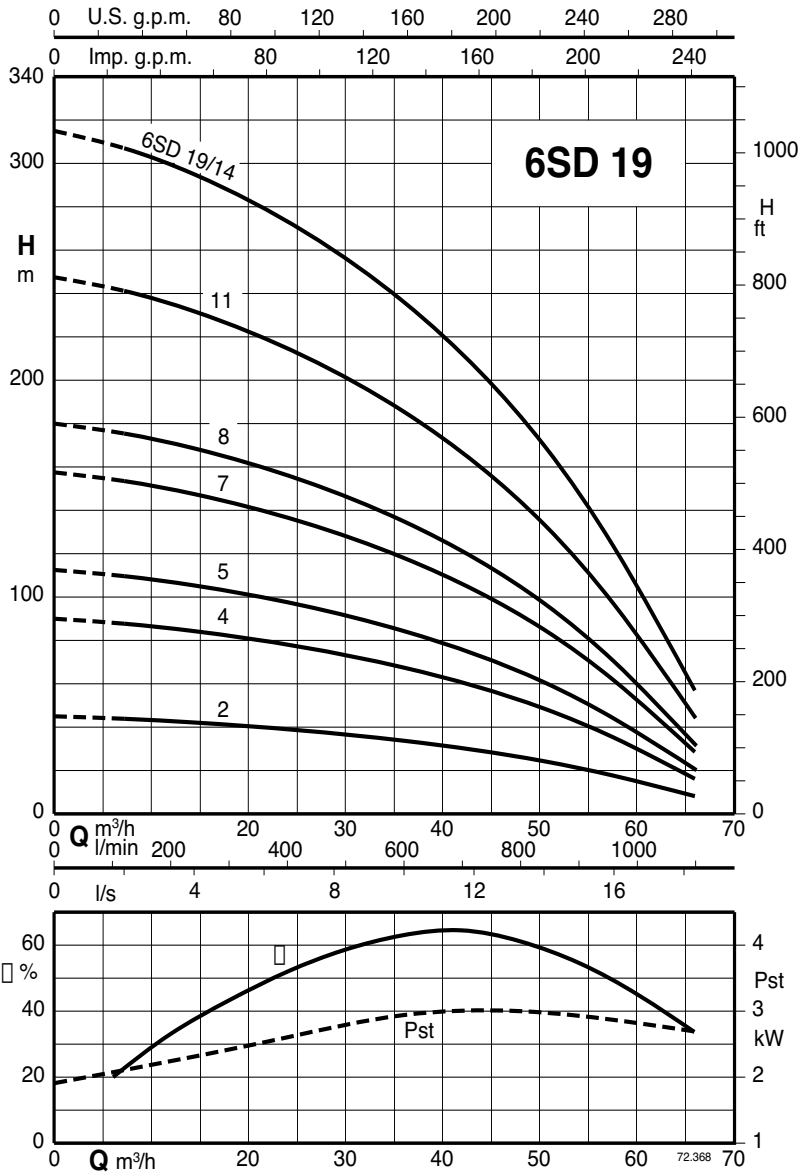

3 ~	P ₂		Q	$n \approx 3450$ rpm											
	kW	HP		m ³ /h											
				6	12	18	24	30	36	42	48	54	60	66	
6SD 19/2-60	5,5	7,5	H m	44	43	41	39	37	34	31	27	21	15	8	
6SD 19/4-60	11	15		88	86	82	79	74	68	61	51	41	29	16	
6SD 19/5-60	15	20		110	107	103	98	92	85	75	65	52	37	20	
6SD 19/7-60	18,5	25		153	149	144	137	129	119	106	91	73	51	28	
6SD 19/8-60	22	30		177	172	165	157	148	135	121	104	83	60	32	
6SD 19/11-60	30	40		244	237	228	216	203	187	166	142	115	82	45	
6SD 19/14-60	37	50		310	300	288	275	257	237	212	183	147	104	57	

DN	f	
	mm	kg
G 3 ISO 228	542	58,5
	760	72
	870	81
	1088	98
	1197	117
	1525	140
	1853	196

P₂ Rated motor power output.
Potencia nominal del motor.

H Total head in m
Altura total en m

Tolerances according to UNI EN ISO 9906:2012.
Tolerancias según UNI EN ISO 9906:2012.

6SD 20 60 Hz



Performance - Prestaciones $n \approx 3450$ rpm, dimensions and weights - dimensiones y pesos

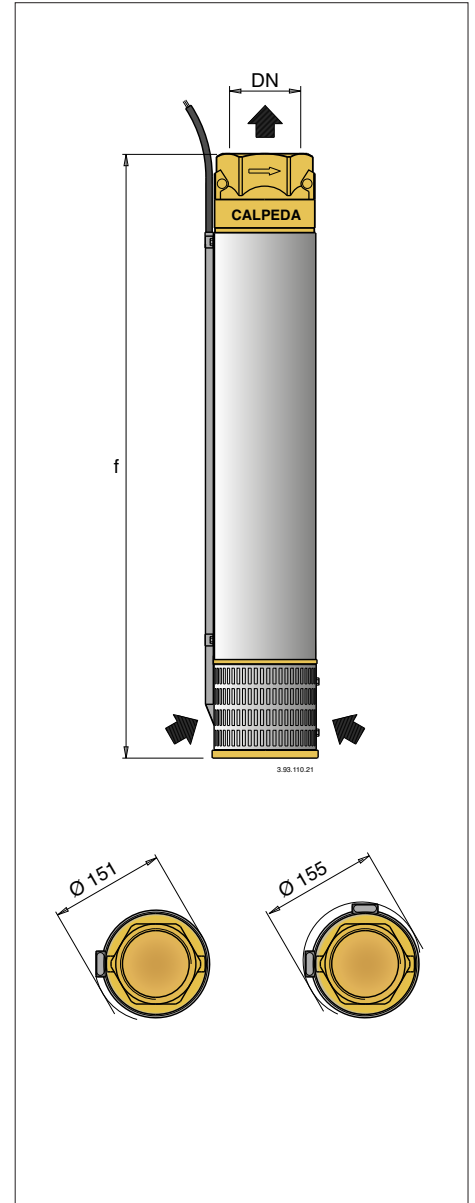
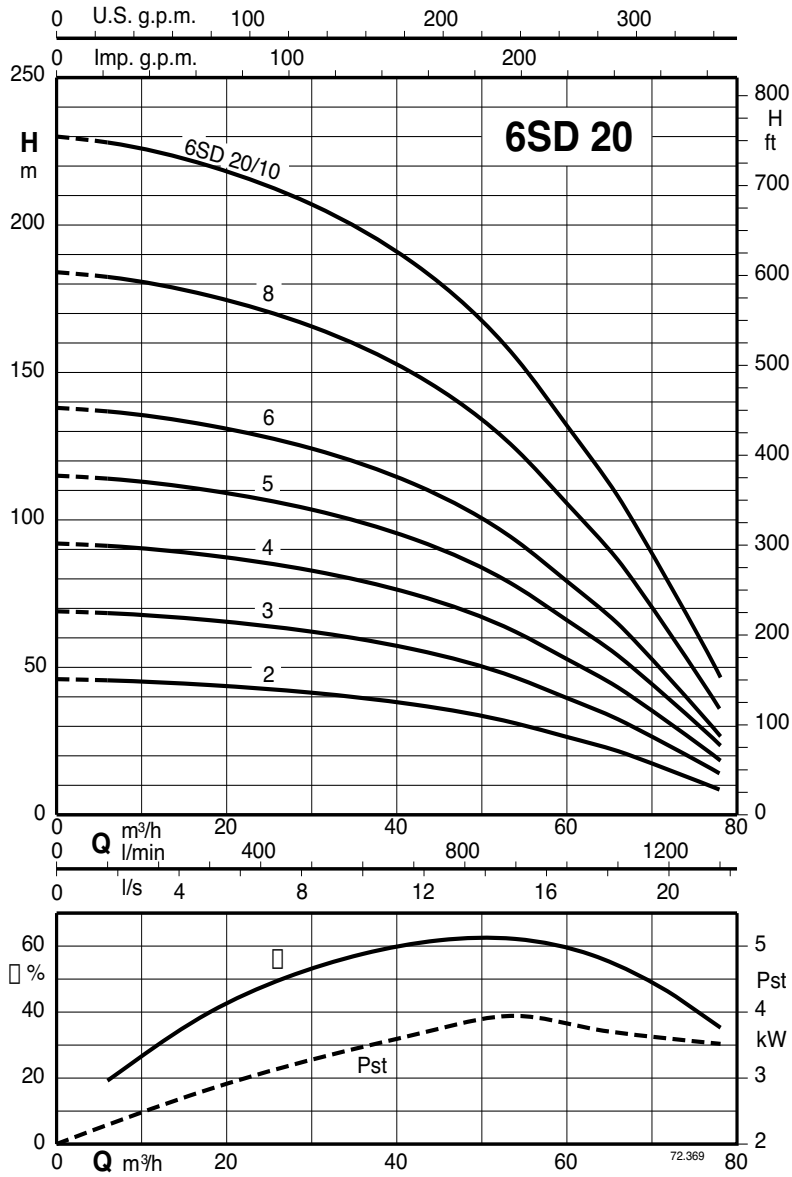

3~	P ₂		Q	n ≈ 3450 rpm												
				H												
	kW	HP		m³/h	12	18	24	30	36	42	48	54	60	66	72	78
6SD 20/2-60	7,5	10	l/min	200	300	400	500	600	700	800	900	1000	1100	1200	1300	
6SD 20/3-60	11	15	m	45	44	42	41	40	37	34	30	26	20	15	9	
6SD 20/4-60	15	20		67	66	64	62	59	56	51	46	39	31	22	13	
6SD 20/5-60	18,5	25		88	87	84	82	78	73	68	61	51	40	30	18	
6SD 20/6-60	22	30		112	109	106	103	98	93	86	77	65	51	38	23	
6SD 20/8-60	30	40		135	132	129	122	112	113	104	93	79	63	45	27	
6SD 20/10-60	37	50		181	177	171	166	158	149	137	123	105	84	60	36	
				226	222	216	208	198	189	173	155	132	106	76	46	

DN	f	
	mm	kg
G 3 ISO 228	542	62
	651	69,5
	760	80
	870	94
	979	112
	1197	132
	1416	152

P₂ Rated motor power output.
Potencia nominal del motor.

H Total head in m
Altura total en m

Tolerances according to UNI EN ISO 9906:2012.
Tolerancias según UNI EN ISO 9906:2012.