

# NM, NMD

**Bombas centrífugas monobloc con orificios roscados**

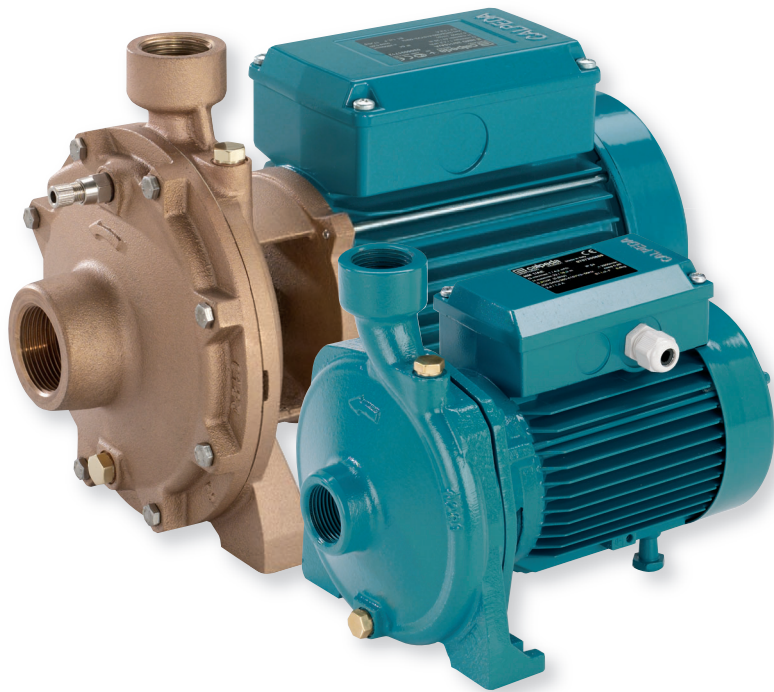

Las Bombas serie NM, B-NM, son conformes al Reglamento Europeo N. 547/2012.

## Materiales

Componentes	NM, NMD	B-NM, B-NMD
Cuerpo bomba	Hierro	Bronce
Acoplamiento	GJL 200 EN 1561	CC480K EN 1982
Rodete	Latón CW617N EN 12165	
	NM 17	
	Hierro GJL 200 EN 1561	Bronce CC480K EN 1982
Eje	Acero al Cr AISI 430	Acero al Cr Ni Mo AISI 316
	Acero al Cr Ni AISI 303 de 1,1-1,5-2,2 kW	
	NM 6	
Sello mecánico	Carbón - Cerámica - NBR	

## Ejecución

Electrobombas centrífugas monobloc con acoplamiento directo motor-bomba y eje único.

**NM:** con un rodete.

**NMD:** con dos rodetes contrapuestos (con empuje axial equilibrado).

Orificios: Roscados UNI-ISO 228/1.

NM, NMD: Ejecución con cuerpo bomba y acoplamiento in hierro.

B-NM, B-NMD: Ejecución con cuerpo bomba y acoplamiento in bronce.

Las bombas en bronce se suministran totalmente pintadas.

## Aplicaciones

- Para líquidos limpios sin partes abrasivas, y no agresivas para los materiales de la bomba (con partes sólidas hasta 0,2% máx).
- Para el aprovisionamiento de agua.
- Para instalaciones de calefacción, acondicionamiento, refrigeración y circulación.
- Para aplicaciones civiles e industriales.
- Para irrigación.

## Límites de empleo

Temperatura del líquido de -10 °C a +90 °C.

Temperatura ambiente hasta 40 °C.

Altura de aspiración manométrica hasta 7 metros.

Presión final máxima admitida en el cuerpo de la bomba 10 bar.

(16 bar para bombas NMD 25/190; NMD 32/210; NMD 40/180).

Servicio continuo.

## Motor

Motor a inducción a 2 polos, 50 Hz (n = 2900 1/min).

**NM, NMD:** trifásico 230/400 V ± 10%, hasta 3 kW;

400/690 V ± 10%, de 4 a 9,2 kW;

**NMM, NMDM:** monofásico 230 V ± 10%, con protector térmico.

Aislamiento clase F. Protección IP 54.

Motor preparado al funcionamiento con convertidor de frecuencia de 1,1 kW.

**Clase de eficiencia IE3 para motores trifásicos (IE2 hasta 0,65 kW).**

Ejecución según EN 60034-1; EN 60034-30-1.

EN 60335-1, EN 60335-2-41.

## Otras ejecuciones bajo demanda

- Otras tensiones.
- Frecuencia 60 Hz.
- Protección IP 55.
- Sello mecánico especial.
- Para líquidos o ambientes con temperaturas más elevadas o más bajas.
- Motor preparado al funcionamiento con convertidor de frecuencia hasta 0,75 kW.

## Campo de aplicaciones n ≈ 2900 1/min

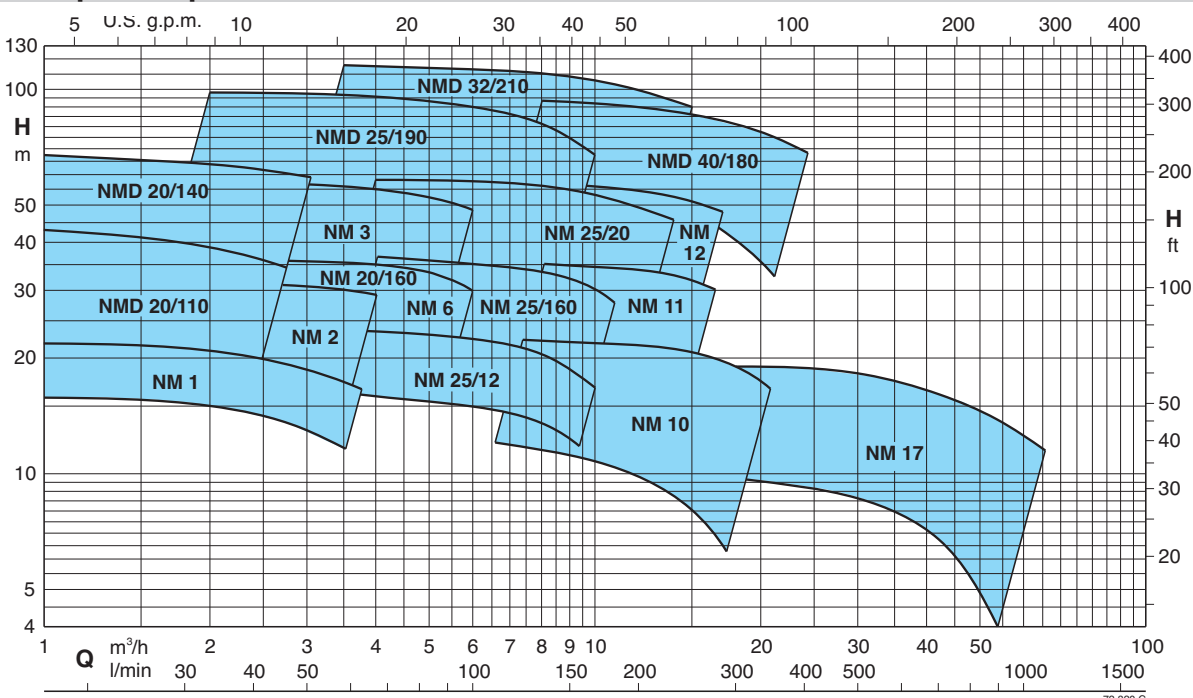

### Prestaciones n ≈ 2900 1/min

	NM	P <sub>2</sub>		Q m <sup>3</sup> /h	Q													
		kW	HP		l/min													
				1	1,2	1,5	1,89	2,4	3	3,6	4,2	4,8	5,4	6	6,6	7,5	8,4	
				l/min	16	20	25	31,5	40	50	60	70	80	90	100	110	125	140
	NM 1/AE ●	0,37	0,5	H m	22	21,6	21,3	20,9	20,3	19,4	18,1	16,3						
	NM 2/B/A ●	0,55	0,75		27	26,5	26	25,5	25	24	23	22	20					
	NM 2/S/A ●	0,55	0,75		31	30,5	30	29	27,5	25,5	23,5	20	16					
	NM 2/A/B ●	0,75	1		33,5	33	32,5	32	31,5	30,5	29,5	28,5	27	26	24			
	NM 6/B ●	0,75	1					30,5	30	29,5	28,5	27,5	26,5	25,5	24	22	18	
	NM 6/A ●	1,1	1,5					35,5	35,2	34,7	34	33	32	30,5	29	27	23,5	19*
	NMM 3/CE	1,1	1,5			37,5	37,5	37	36,5	36	35	34	32					
	NM 3/C/A	1,1	1,5			37,5	37,5	37	36,5	36	35	34	32	30,5	28,5			
	NMM 3/BE	1,5	2			42	42	41,5	41	40,5	40	39	37	35	32			
	NM 3/B/A	1,5	2			47	47	46,5	46	45,5	45	44	43	41,5	40	37,5	33	26
	NMM 3/A/A	1,8	2,5			47,5	47,5	47	46,5	46	45,5	44,5	43,5	42	40,5	38	33,5	26,5
	NM 3/A/B	2,2	3			56	55,5	55,5	55	54,5	53,5	52,5	51,5	50	48	46	42	36

B-NM B-NMD	NM NMD	P <sub>2</sub>		Q m <sup>3</sup> /h	Q													
		kW	HP		l/min													
				1	1,2	1,5	1,89	2,4	3	3,6	4,2	4,8	5,4	6	6,6	7,5	8,4	
				l/min	16	20	25	31,5	40	50	60	70	80	90	100	110	125	140
B-NMD 20/110B/A ●	NMD 20/110B/A ●	0,45	0,6	H m	33	32	31	29	26,5	23	18							
B-NMD 20/110Z/A ●	NMD 20/110Z/A ●	0,55	0,75		37	36	35	33	30,5	27,5	23	18						
B-NMD 20/110A/B ●	NMD 20/110A/B ●	0,75	1		43	42	40,5	39	36,5	33	29	25						
B-NMDM 20/140BE	NMDM 20/140BE	1,1	1,5		52	51,5	51	50	48,5	47	45							
B-NMD 20/140B/A	NMD 20/140B/A	1,1	1,5		53	52,5	52	51	50	48	46	43,5	40					
B-NMDM 20/140AE	NMDM 20/140AE	1,5	2		57,5	57	56,5	55,5	54	51,5	49	46	43	40	36			
B-NMD 20/140A/A	NMD 20/140A/A	1,5	2		67	66,5	66	64,5	63	61,5	59	57	53,5	50	46			
B-NM 20/160BE ●	NM 20/160BE ●	0,75	1					30,5	30	29,5	28,5	27,5	26,5	25,5	24	22		
B-NM 20/160A/A ●	NM 20/160A/A ●	1,1	1,5					36	35,5	35	34,5	33,5	32	30,5	29	27		

B-NM B-NMD	NM NMD	P <sub>2</sub>		Q m <sup>3</sup> /h	Q														
		kW	HP		l/min														
				2,4	3	3,6	4,8	6	6,6	7,5	8,4	9,6	10,8	12	13,2	15	16,8	18	
				l/min	40	50	60	80	100	110	125	140	160	180	200	220	250	280	300
B-NM 25/12B/A ●	NM 25/12B/A ●	0,55	0,75	H m	20	19,9	19,8	19,3	18,5	18	17,3	16,3	15	13,2	11				
B-NM 25/12A/B ●	NM 25/12A/B ●	0,75	1		23,5	23,4	23,3	22,9	22,1	21,7	20,9	20	18,7	17,1	15,2				
B-NM 25/160B/A ●	NM 25/160B/A ●	1,1	1,5			31	30,7	30	28,5	28	27	26	23						
B-NM 25/160A/A ●	NM 25/160A/A ●	1,5	2			36,5	36,2	35,5	34,5	34	33,5	32,5	31	28,5	26				
B-NM 25/200B/C	NM 25/20B/C	2,2	3			42,2	41,9	41,4	40,7	40,2	39,7	39	37,9	36,7	35,2	33,4			
B-NM 25/200A/B	NM 25/20A/B	3	4			49,9	49,8	49,4	48,9	48,5	48,1	47,5	46,6	45,6	44,4	43	40,8	37,9	
B-NM 25/200S/C	NM 25/20S/C	4	5,5			57,4	57,3	57	56,8	56,5	56,2	55,8	55,1	54,3	53,2	52	49,9	47,2	44,9
B-NMD 25/190C/B	NMD 25/190C/B	2,2	3		62	60,5	59	55,5	51	48,5	44	38							
B-NMD 25/190B/A	NMD 25/190B/A	3	4		76	75	74	70	66	64	60	54	46						
B-NMD 25/190A/B	NMD 25/190A/B	4	5,5		98	97	96	93,5	90	88	84	79	70						

	NM	P <sub>2</sub>		Q m <sup>3</sup> /h	Q														
		kW	HP		l/min														
				6,6	7,5	8,4	9,6	10,8	12	13,2	15	16,8	18,9	21	24	27	30		
				l/min	110	125	140	160	180	200	220	250	280	315	350	400	450	500	
	NM 10/FE ●	0,55	0,75	H m	12,5	12,5	12	11,5	11	10	9	7,5							
	NM 10/DE ●	0,75	1		18	18	17,5	17	16,5	16	15,5	14							
	NM 10/A/A ●	1,1	1,5		23	23	22,5	22	21,5	21	20,5	19							
	NM 10/S/A ●	1,5	2		23,5	23,5	23	22,5	22	21,5	21	20,5	19	18,5	16,5	13			
	NMM 11/BE	1,5	2		26,5	25,5	25	24	23	22,5	21,5	19,5	17,5						
	NM 11/B/A	1,5	2		29,5	29,5	29	28,5	27,5	27	26	25*	22,5*						
	NMM 11/A	1,8	2,5		30,2	30,1	29,8	29,4	28,8	28,1	27,4	26	24,5						
	NM 11/A/B	2,2	3		35,5	35,5	35	34,5	34	33,5	33	32*	30*						
	NM 12/D/B	2,2	3		38	37,5	37	36	35	33,5	32								
	NM 12/C/A	3	4		45	44,5	44	43,5	42,5	41	40	38	36						
	NM 12/A/B	4	5,5		57,5	57	56	55,5	55	54,5	53,5	51,5	49						

### Prestaciones $n \approx 2900$ 1/min

B-NMD	NMD	P <sub>2</sub>		Q m <sup>3</sup> /h l/min	5,4	6	6,6	7,5	8,4	9,6	10,8	12	13,2	15	16,8	18,9	21	24
		kW	HP		90	100	110	125	140	160	180	200	220	250	280	315	350	400
B-NMD 32/210D/B	NMD 32/210D/B	4	5,5	H m	71	69	67,5	65	62,5	58	53	46	37*					
B-NMD 32/210C/A	NMD 32/210C/A	5,5	7,5		84	83	82	81	79	76	73	69	64*	54*				
B-NMD 32/210B/A	NMD 32/210B/A	7,5	10		104	103	102	100	98	95	92	88	84*	76*				
B-NMD 32/210A/B	NMD 32/210A/B	9,2	12,5		114	113	112	110	108	105	103	99	96*	90*				
B-NMD 40/180D/B	NMD 40/180D/B	4	5,5					60	59,5	57	56	53	51,5	48	44	39	34*	25*
B-NMD 40/180C/A	NMD 40/180C/A	5,5	7,5					69	68	67	66	64,5	63	60	57	53	48*	40*
B-NMD 40/180B/A	NMD 40/180B/A	7,5	10					87	86	85	84	82,5	81	78	75	71	66*	59*
B-NMD 40/180A/B	NMD 40/180A/B	9,2	12,5					94	93	92	91	89,5	88	85	82	78	74*	67*

B-NM	NM	P <sub>2</sub>		Q m <sup>3</sup> /h l/min	21	24	27	30	33	37,8	42	48	54	60	66	75	84	96
		kW	HP		350	400	450	500	550	630	700	800	900	1000	1100	1250	1400	1600
B-NM 17/H/A ●	NM 17/H/A ●	1,1	1,5	H m	9,5	9,2	9	8,6	8,2	7,5	6,7	5,5	3,5*					
B-NM 17/G/A ●	NM 17/G/A ●	1,5	2		12	11,7	11,5	11,2	11	10,3	9,7	8,5	7*	4*				
B-NM 17/F/B	NM 17/F/B	2,2	3			16	16	15,5	15	14,5	14	13	11,5*	10*	8*			
B-NM 17/D/A	NM 17/D/A	3	4					18	18	17,5	17	16,5	15,5	14*	13*	11,5*		

NM, NMD Ejecución normal.  
B-NM, B-NMD Ejecución en bronce.

P<sub>2</sub> Potencia nominal del motor.  
H Altura total en m.

● Con motor monofásico = NMM - NMDM.  
\* Altura máxima de aspiración manométrica 1-2 m.  
Tolerancias según UNI EN ISO 9906:2012.

### Intensidades nominales

	P <sub>1</sub>		P <sub>2</sub>		230 V 1~ IN A	IA/IN
	kW	kW	HP	HP		
	0,62	0,37	0,5	0,5	3	2,7
	0,72	0,45	0,6	0,6	3,6	2,9
	1	0,55	0,75	0,75	4,5	2,3
* NMM 25/12B/A	0,9	0,55	0,75	0,75	4,2	2,5
* NMM 10/FE	0,9	0,55	0,75	0,75	4,2	2,5
	1,3	0,75	1	1	6	3
* NMM 25/12A/A	1,2	0,75	1	1	5,4	3,3
* NMM 10/DE	1,2	0,75	1	1	5,8	2,6
	1,6	1,1	1,5	1,5	7,4	3
	2	1,5	2	2	9,2	3,8
	2,5	1,8	2,5	2,5	11,2	4,5

	P <sub>2</sub>		230 V Δ / 400 V Y 400 V Δ / 690 V Y			IA/IN
	kW	HP	IN A	IN A	IN A	
	0,37	0,5	2,3	1,3		3,8
	0,45	0,6	2,3	1,3		3,5
	0,55	0,75	3	1,7		3,6
* NM 25/12B/A	0,55	0,75	2,8	1,6		3,9
* NM 10/FE	0,55	0,75	4	2,3		4,8
	0,75	1	3,7	2,2		5,5
* NM 25/12A/B	0,75	1	3,5	2		6,1
* NM 10/DE	0,75	1	4	2,3		6,1
	1,1	1,5	4,6	2,7		5,5
	1,5	2	7,5	4,3		6,1
	2,2	3	9,2	5,3		8,4
* NM 25/20B/C	2,2	3	9,6	5,5		8,1
	3	4	11,5	6,6		8,2
	4	5,5		9,6	5,5	8,9
	5,5	7,5		10,9	6,3	9,1
	7,5	10		14,3	8,3	9,1
	9,2	12,5		18,5	10,7	8,2

P<sub>1</sub> Máxima potencia absorbida.  
P<sub>2</sub> Potencia nominal del motor.  
IA/IN Intensidad de arranque / Intensidad nominal

### Curvas Características $n \approx 2900$ 1/min

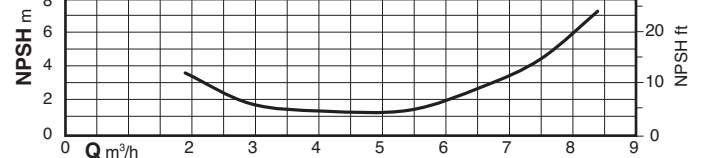
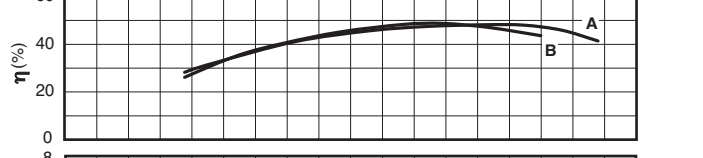
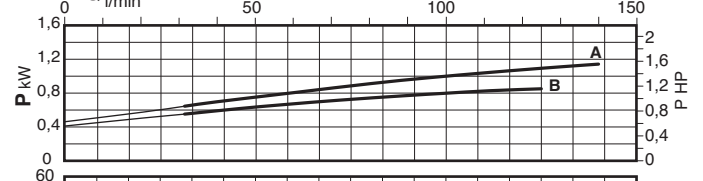
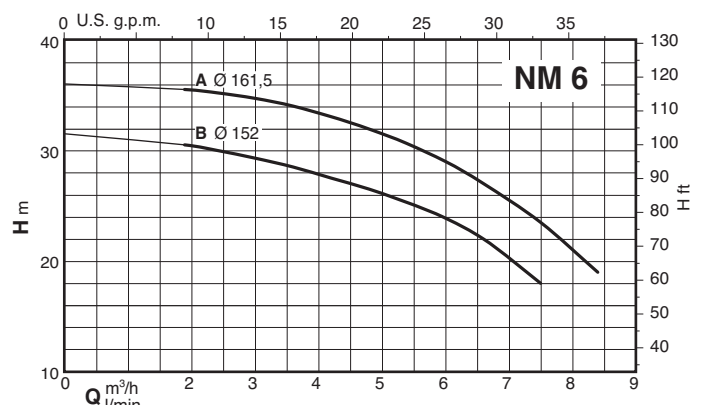
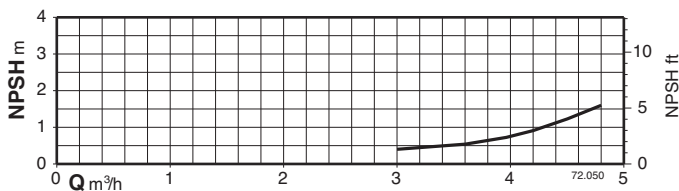
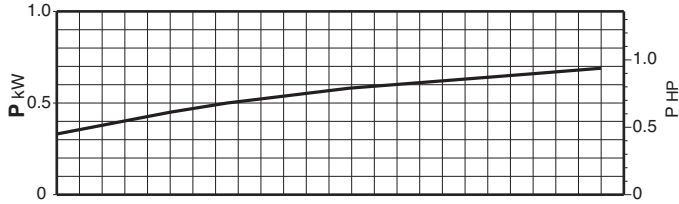
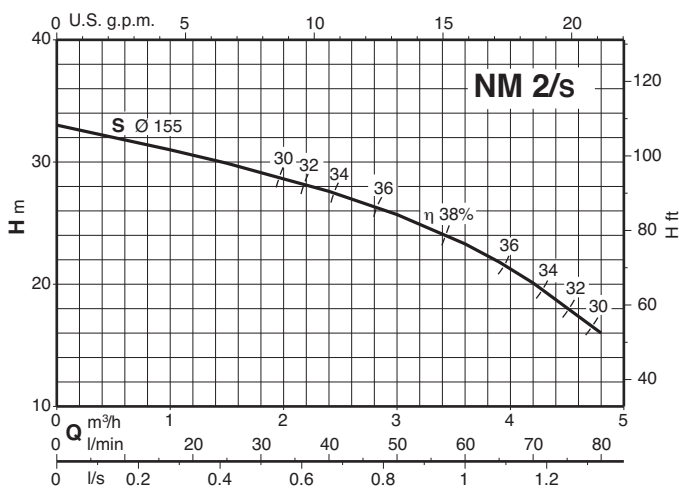
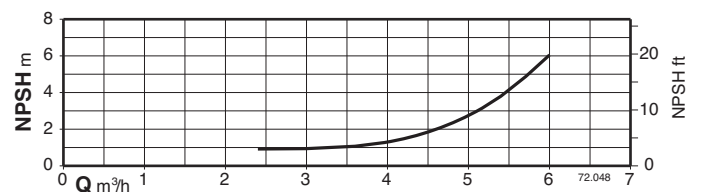
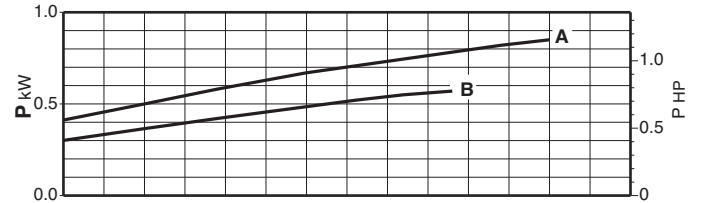
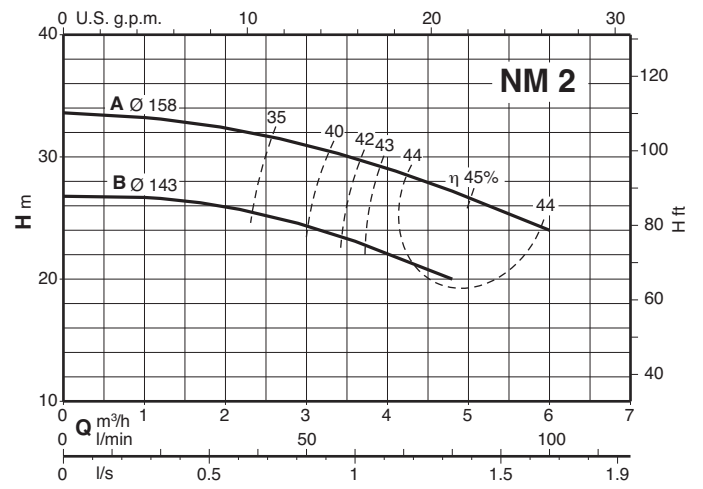
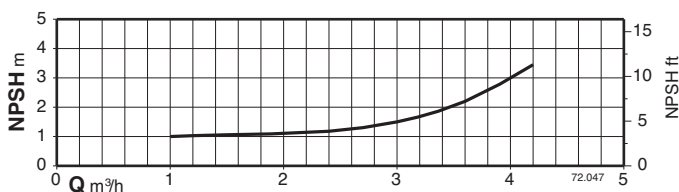
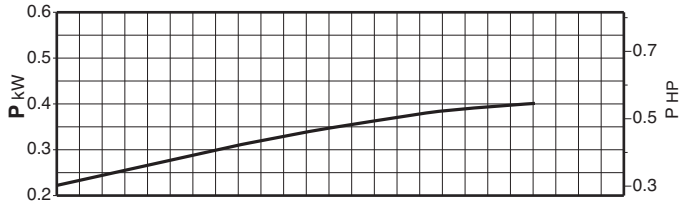
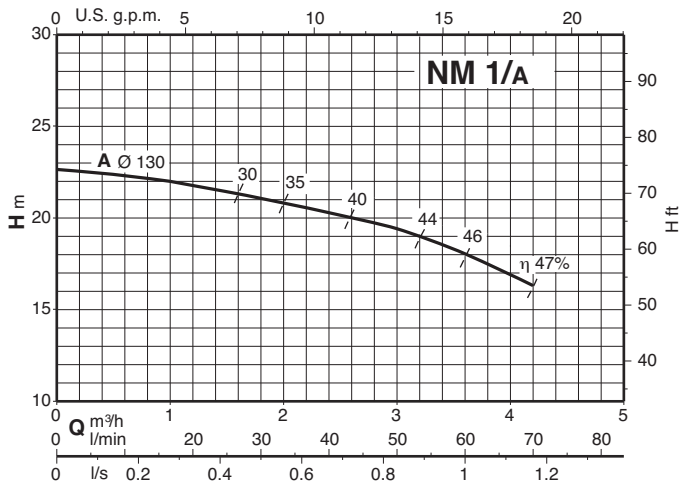

### Curvas Características $n \approx 2900$ 1/min

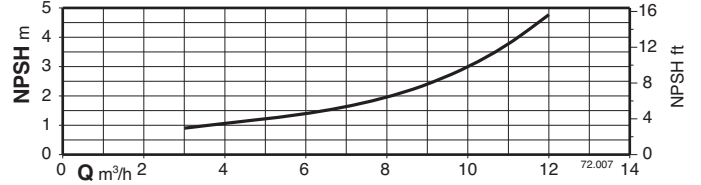
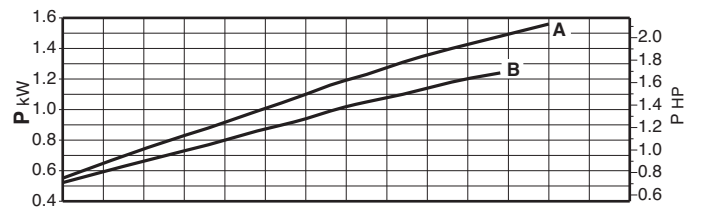
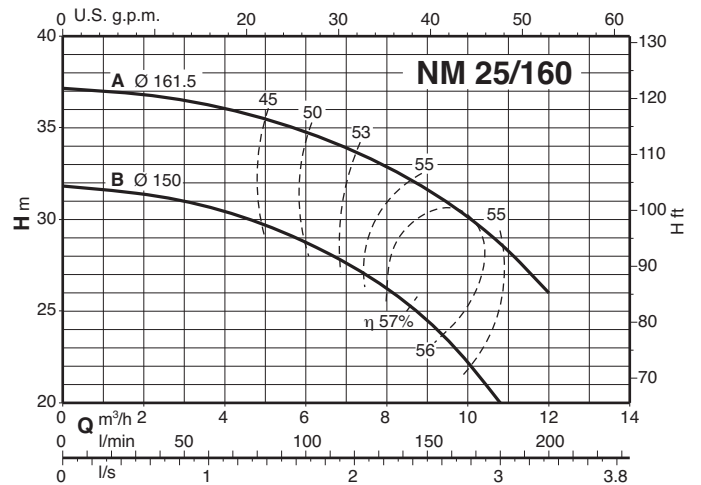
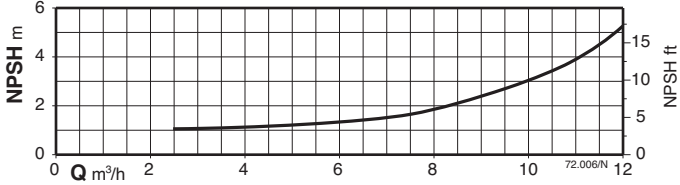
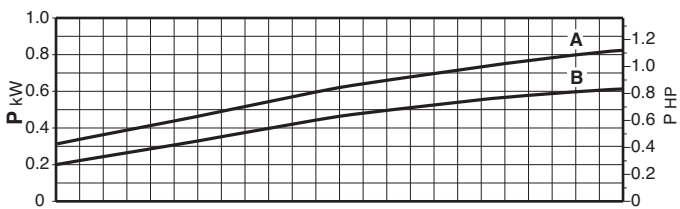
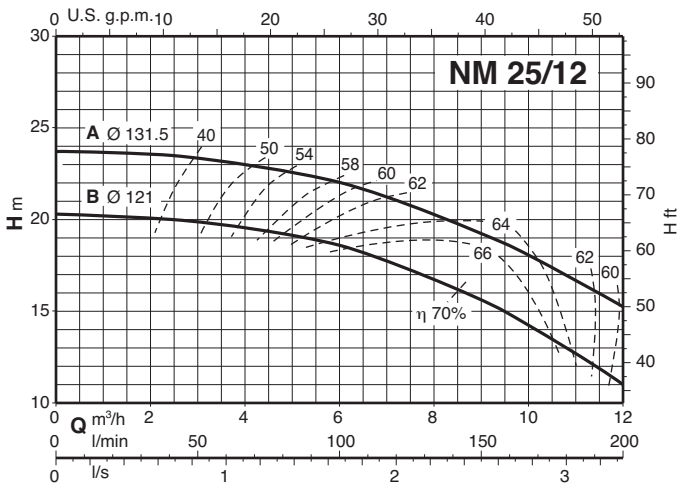
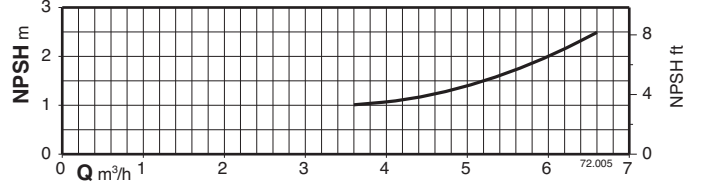
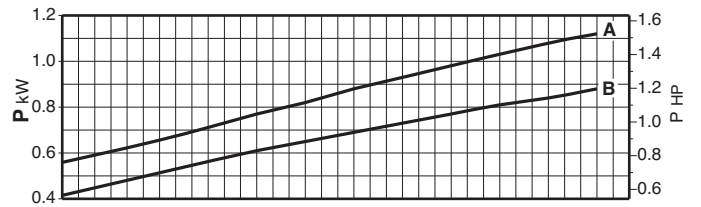
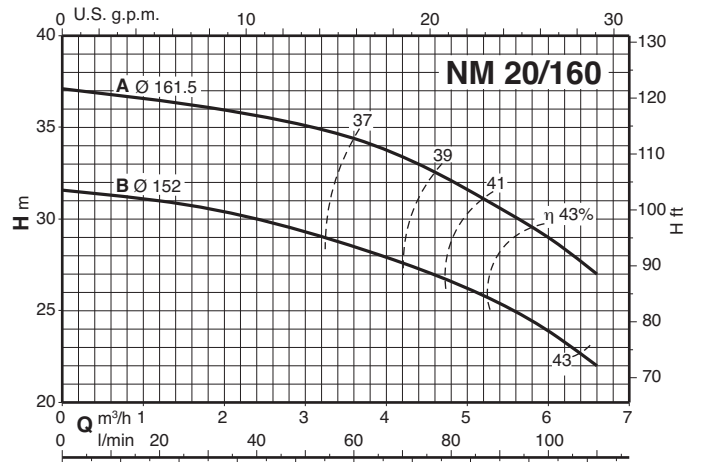
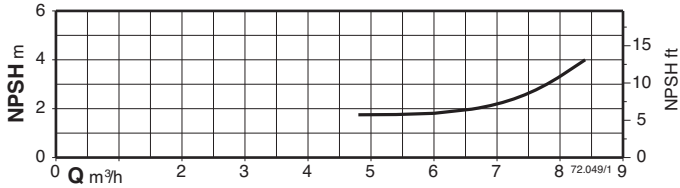
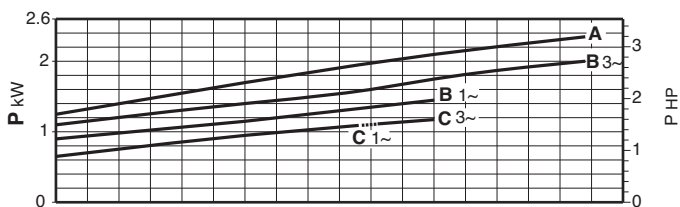
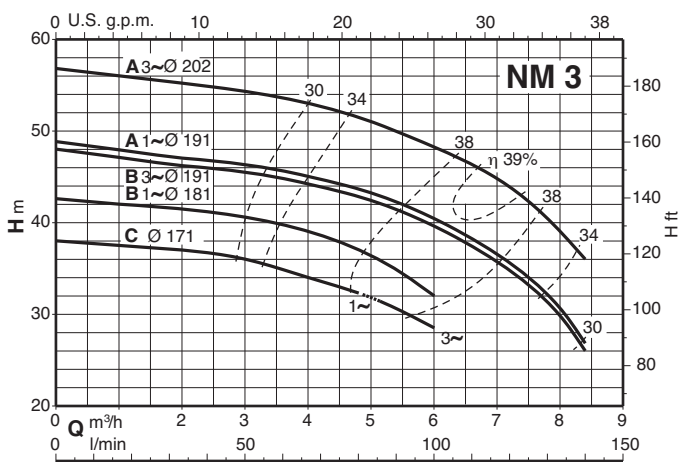

### Curvas Características $n \approx 2900$ 1/min

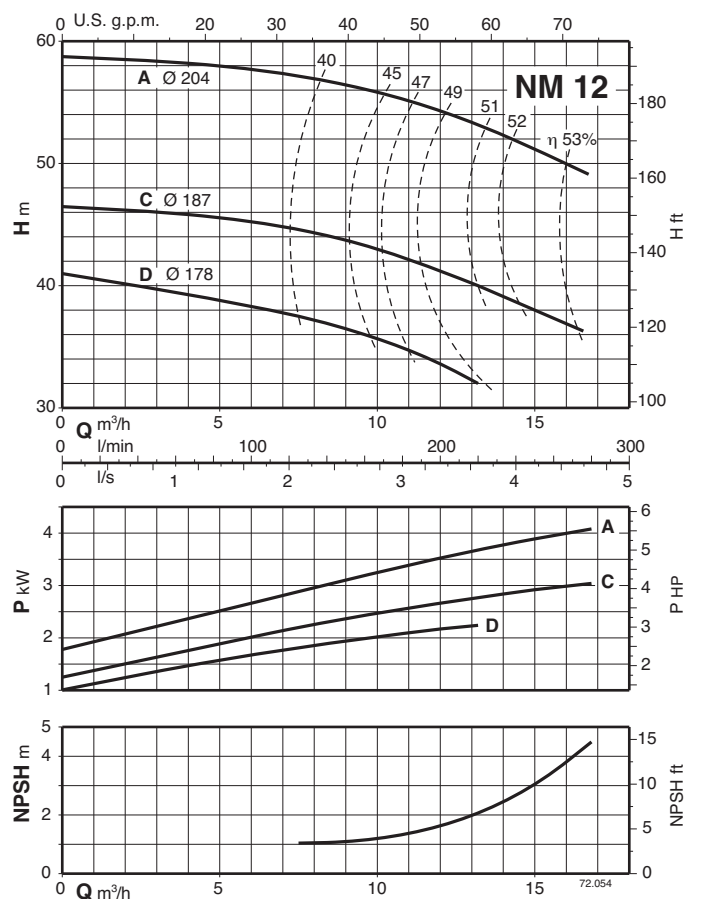
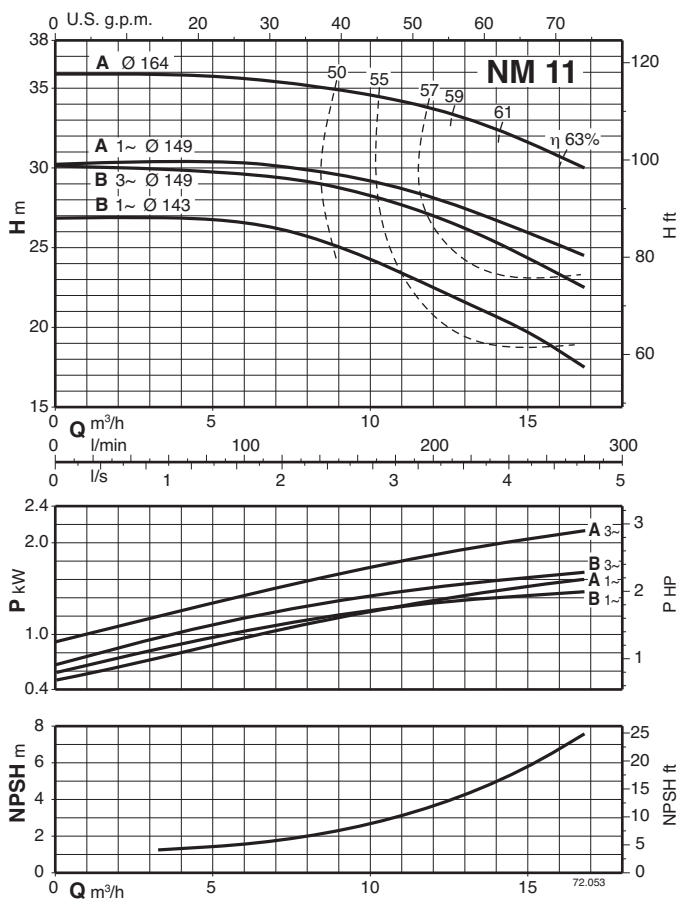
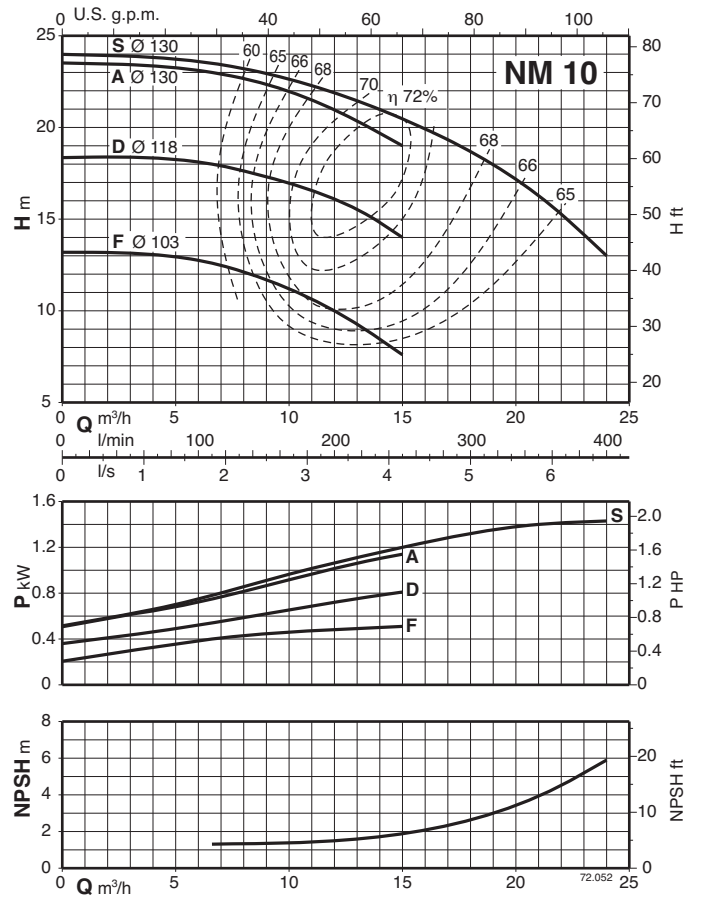
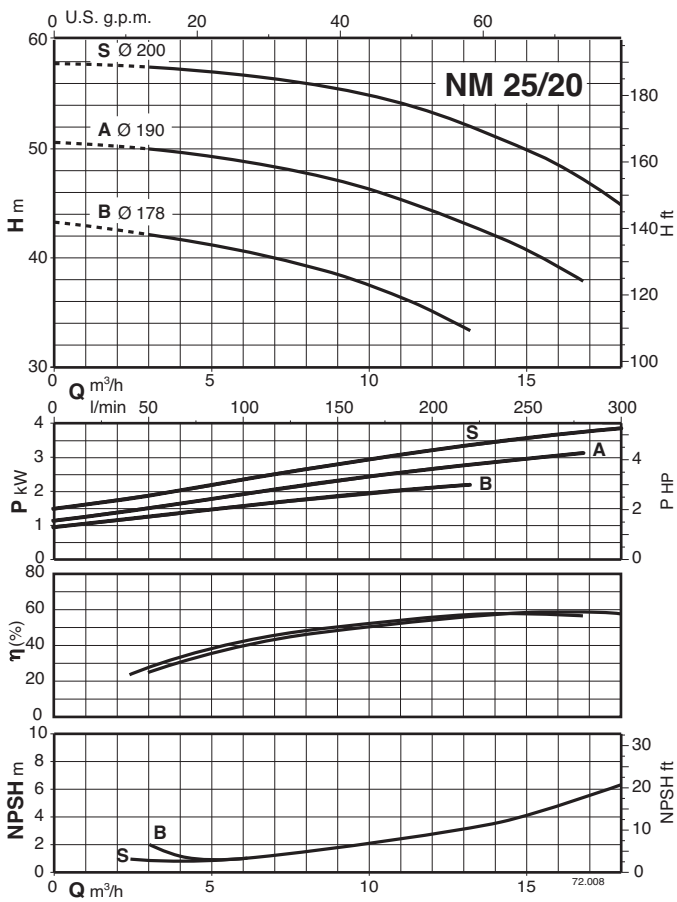

### Curvas Características $n \approx 2900$ 1/min

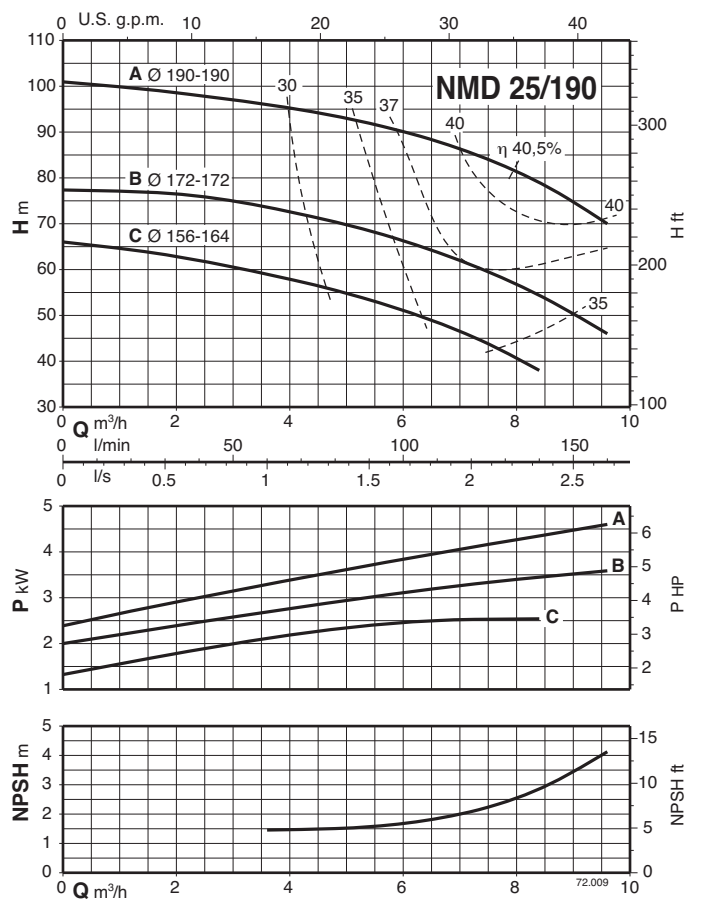
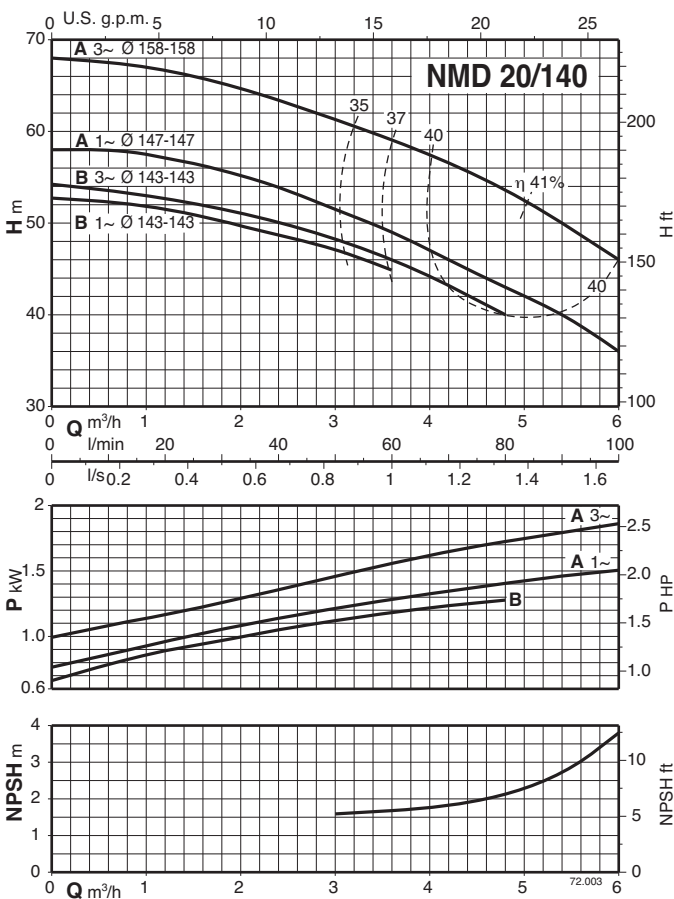
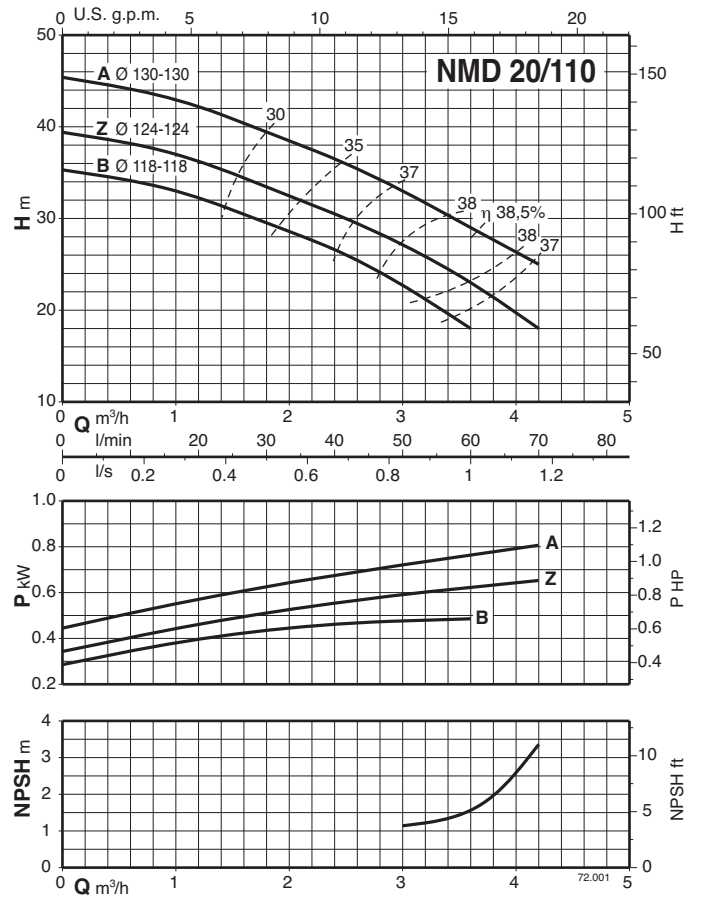
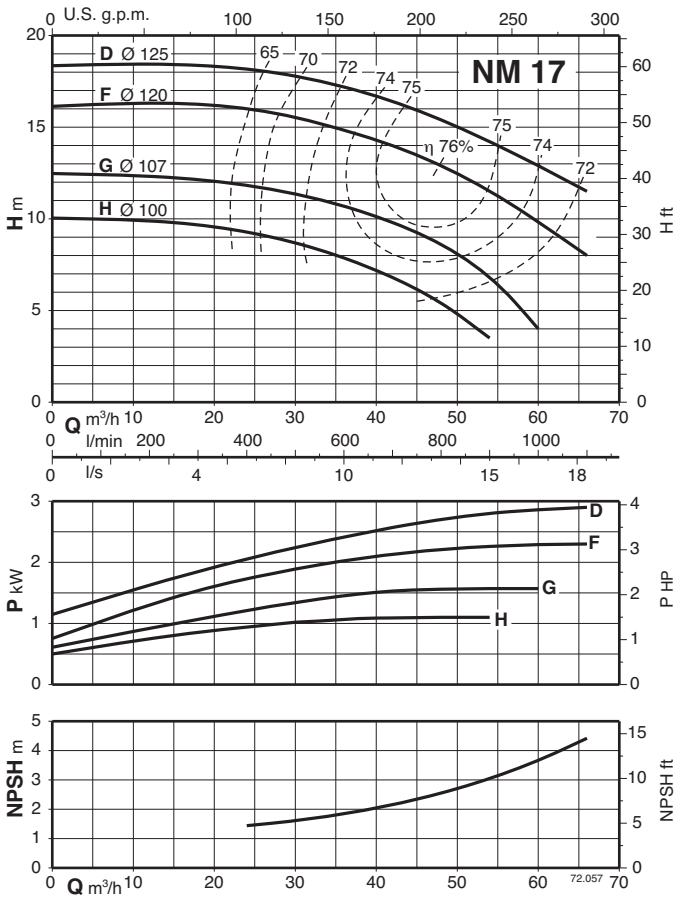

**Curvas Características  $n \approx 2900$  1/min**

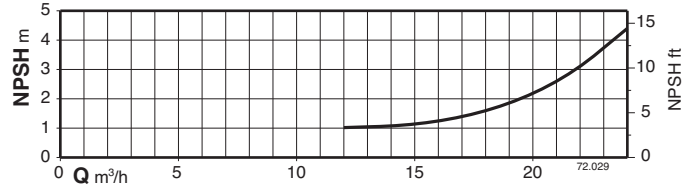
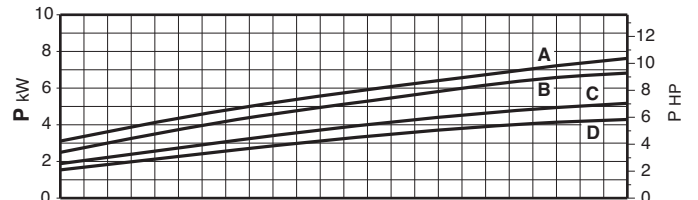
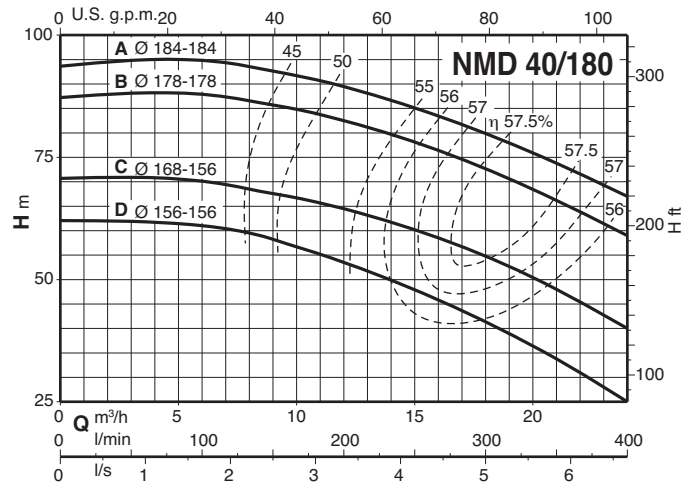
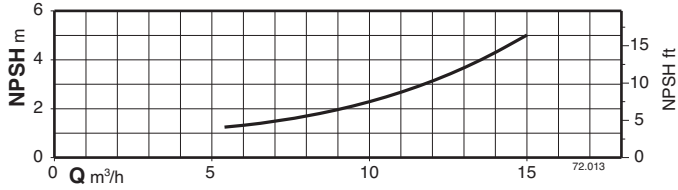
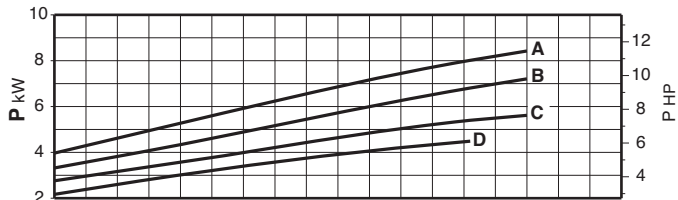
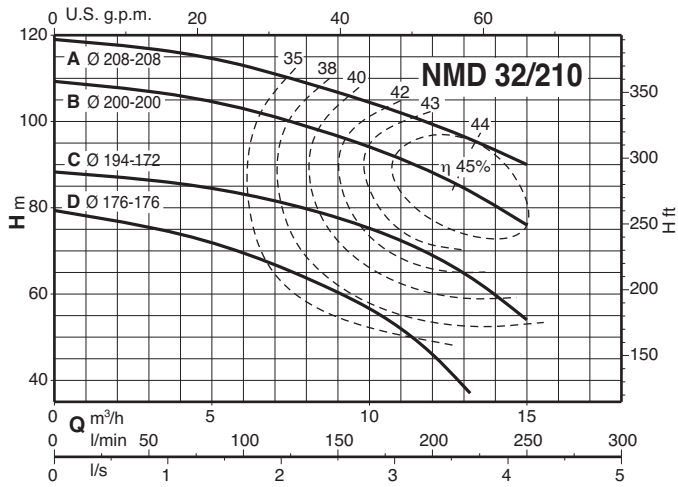



### Dimensiones y pesos

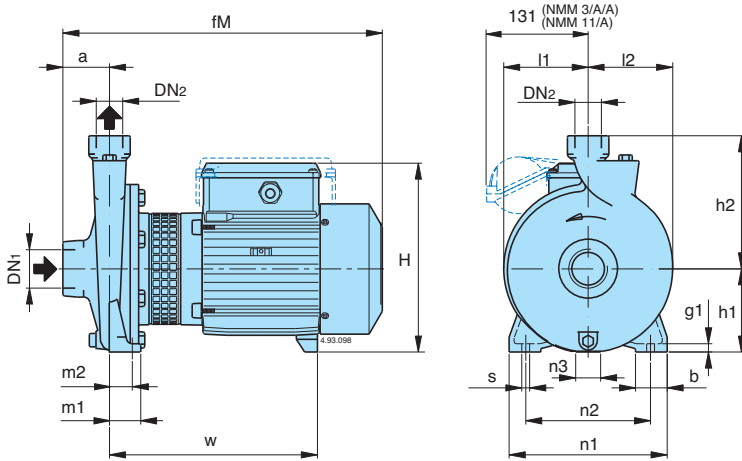

TIPO	NMM kg	NM kg	B-NM kg
NM 1/AE	8,7	8,6	
NM 2/B/A	14	13,1	
NM 2/S/A	14,2	13,3	
NM 2/A/B	15,1	15	
NM 6/B	17,8	17,6	
NM 6/A	19,3	19	
NM 3/C/A	24	22,9	
NM 3/B/A	26	25,1	
NM 3/A/B	30,4	29,1	
B- NM 20/160BE	19,9	18,4	21
B- NM 20/160A/A	20,7	19,7	22,5
B- NM 25/12B/A	13,2	12,3	13,5
B- NM 25/12A/B	14,2	14,1	15,3
B- NM 25/160B/A	20,4	19,7	22,8
B- NM 25/160A/A	22,5	21,5	24
NM 25/20B/C		31,6	
NM 25/20A/B		40,9	
NM 25/20S/C		42,2	
B- NM 25/200B/C			35,7
B- NM 25/200A/C			43,7
B- NM 25/200S/C			45,2
NM 10/FE	19,3	18,5	
NM 10/DE	19,4	18,8	
NM 10/A/A	20,2	19,3	
NM 10/S/A	22,1	21,5	
NM 11/B/A	24,7	24,1	
NM 11/A/B		28,1	
NM 12/D/B		33,5	
NM 12/C/A		42	
NM 12/A/B		43,5	
B- NM 17/H/A	23	22,2	29,2
B- NM 17/G/A	24,2	23,2	30,2
B- NM 17/F/B		28,2	35,2
B- NM 17/D/A		36,2	43,2

B-NM	NM	DN <sub>1</sub> ISO 228	DN <sub>2</sub> ISO 228	mm															
				a	fM	h <sub>1</sub>	h <sub>2</sub>	H	m <sub>1</sub>	m <sub>2</sub>	n <sub>1</sub>	n <sub>2</sub>	n <sub>3</sub>	b	s	l <sub>1</sub>	l <sub>2</sub>	w	g <sub>1</sub>
	NM 1/AE	G 1	G 1	40	261	80	132	176	40	32	170	140	17	35	9,5	77	81	171	10
	NM 2/A/B-S/A-B/A	G 1	G 1	45	305	95	150	207	40	32	190	160	17	35	9,5	87	90	203	10
	NM 6/A-B	G 1 1/4	G 1	53	349	100	150	213	37,5	27,5	190	150	17	38	9,5	102	102	225	10
	NM 3/B/A-C/A	G 1	G 1	50	375	112	180	240	55	43	245	205	37	45	11,5	110	113	244	12
	NM 3/A/B	G 1	G 1	50	415	112	180	240	55	43	245	205	37	45	11,5	110	113	284	12
B-NM 20/160A/A-BE	NM 20/160A/A-BE	G 1 1/4	G 3/4	53	375	100	150	228	37,5	27,5	190	150	30	38	9,5	102	102	246	10
B-NM 25/12A/B-B/A	NM 25/12A/B-B/A	G 1 1/2	G 1	56	313	90	140	199	37,5	27,5	170	130	9	38	9,5	85	88	195	10
B-NM 25/160A/A-B/A	NM 25/160A/A-B/A	G 1 1/2	G 1	56	380	100	160	228	37,5	27,5	190	150	30	38	9,5	102	102	246	10
	NM 25/20B/C	G 1 1/2	G 1	63	433	125	180	253	45	32,5	245	200	49	45	11,5	125	125	291	11
	NM 25/20A/B-S/C	G 1 1/2	G 1	63	460	125	180	263	45	32,5	245	200	42	45	11,5	125	125	295	11
B-NM 25/200B/C		G 1 1/2	G 1	63	445	125	180	253	45	32,5	245	200	49	45	11,5	125	125	303	11
B-NM 25/200A/B-S/C		G 1 1/2	G 1	63	460	125	180	263	45	32,5	245	200	42	45	11,5	125	125	295	11
	NM 10/S/A-A/A-DE-FE	G 2	G 1 1/4	63	382	100	150	228	50	35	190	140	30	50	13	90	97	239	14
	NM 11/B/A	G 2	G 1 1/4	70	400	112	170	240	50	35	210	160	37	50	15	103	110	247	14
	NM 11/A/B	G 2	G 1 1/4	70	440	112	170	240	50	35	210	160	37	50	15	103	110	287	14
	NM 12/D/B	G 2	G 1 1/4	70	440	132	190	260	50	35	240	190	47	50	15	125	127	287	14
	NM 12/A/B-C/A	G 2	G 1 1/4	70	470	132	190	270	50	35	240	190	45	50	15	125	127	300	14
B-NM 17/G/A-H/A	NM 17/G/A-H/A	G 2 1/2	G 2 1/2	80	417	112	160	240	50	35	210	160	37	50	14	96	113	257	14
B-NM 17/F/B	NM 17/F/B	G 2 1/2	G 2 1/2	80	463	112	160	240	50	35	210	160	37	50	14	96	113	304	14
B-NM 17/D/A	NM 17/D/A	G 2 1/2	G 2 1/2	80	480	112	160	250	50	35	210	160	20	50	14	96	113	295	14

### Dimensiones y pesos

#### NMD 20/110

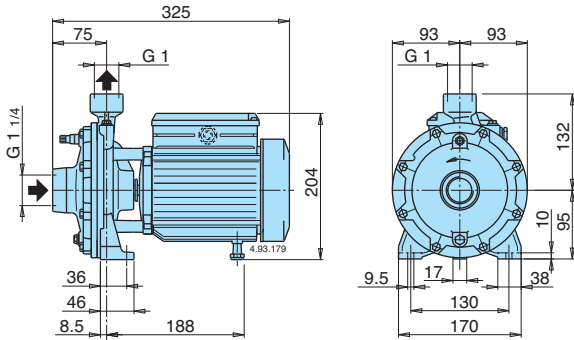

TIPO	NMDM kg	NMD kg	B-NMD kg
B- NMD 20/110B/A	13	12,1	13,4
B- NMD 20/110Z/A	14	13	14,2
B- NMD 20/110A/B	15,1	14,2	17,4

#### NMD 20/140 NMD 25/190

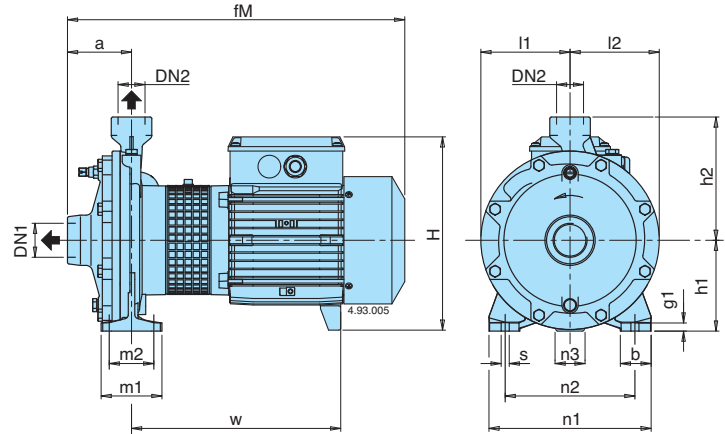

TIPO	NMDM kg	NMD kg	B-NMD kg
B- NMD 20/140B/A	23,9	22,7	25,2
B- NMD 20/140A/A	25,2	24,8	27,6
B- NMD 25/190C/B		42	45,7
B- NMD 25/190B/A		49,7	54
B- NMD 25/190A/B		51,5	55,5

B-NMD	NMD	DN1 ISO 228	DN2 ISO 228	mm															
				a	fM	h1	h2	H	m1	m2	n1	n2	n3	b	s	l1	l2	w	g1
B- NMD 20/140A/A-B/A	NMD 20/140A/A-B/A	G 1 1/4	G 1	80	417	112	152	243	75	55	200	160	37	38	9,5	110	110	256	10
B- NMD 25/190C/B	NMD 25/190C/B	G 1 1/2	G 1	97	487	140	180	268	100	70	240	190	50	50	14	133	133	314	13
B- NMD 25/190A/B-B/B	NMD 25/190A/B-B/A				500			278					49					306	

#### NMD 32/210 NMD 40/180

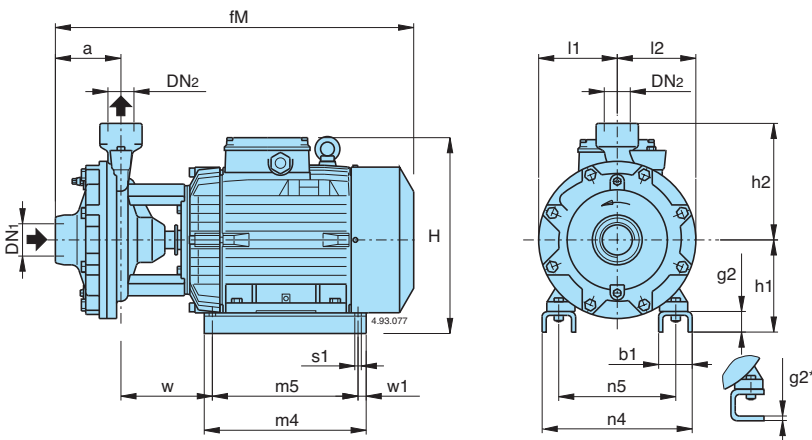

TIPO	NMD kg	B-NMD kg
B- NMD 32/210D/B	60,5	66,5
B- NMD 32/210C/A	71	77
B- NMD 32/210B/A	77	82,5
B- NMD 32/210A/B	99	105
B- NMD 40/180D/B	59,5	65,5
B- NMD 40/180C/A	70	76
B- NMD 40/180B/A	76	81,5
B- NMD 40/180A/B	97	102

B-NMD	NMD	DN1 ISO 228	DN2 ISO 228	mm															
				a	fM	h1	h2	H	m4	m5	n4	n5	w1	b1	s1	l1	l2	w	g2
B- NMD 32/210D/B	NMD 32/210D/B			110	530	155		293	205	175	194	140		54	10			139	6*
B- NMD 32/210B/A -C/A	NMD 32/210B/A -C/A	G 2	G 1 1/4	110	550	150	215	310	280	250	258	190	15	68	12	150	150	108	38
B- NMD 32/210A/B	NMD 32/210A/B				625	170		355	298	268	286	216		70	12			152	38
B- NMD 40/180D/B	NMD 40/180D/B				535	155		293	205	175	194	140		54	10			133	6*
B- NMD 40/180B/A -C/A	NMD 40/180B/A -C/A	G 2	G 1 1/2	121	555	150	215	310	280	250	258	190	15	68	12	145	145	102	38
B- NMD 40/180A/B	NMD 40/180A/B				630	170		355	298	268	286	216		70	12			145	38

## Características constructivas

### NM

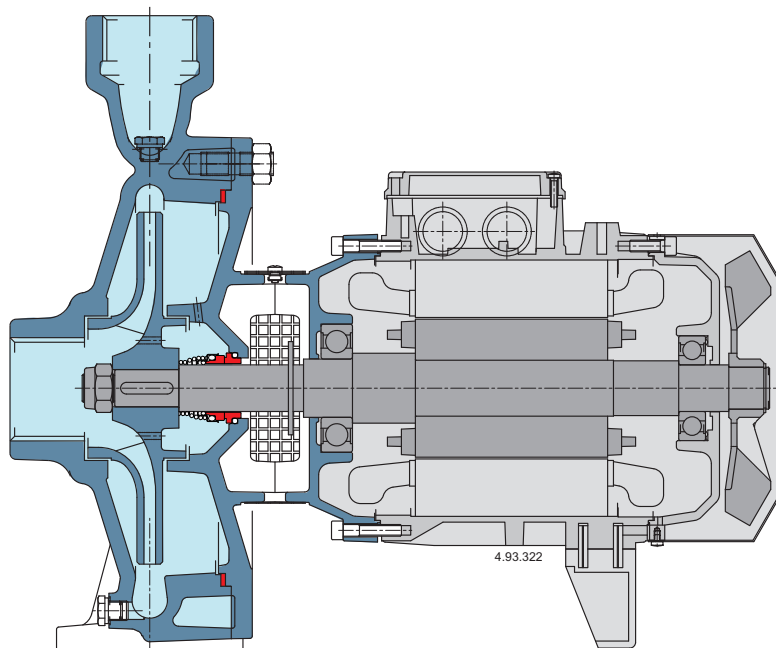

#### Diseño compacto

El diseño compacto permite una fácil instalación incluso en espacios reducidos.

#### Robustez

La estructura mecánica de las partes hidráulicas en contacto con el líquido bombeado están dimensionadas para garantizar la máxima resistencia a la tensión mecánica.

#### Diseño exclusivo

Un innovador protector patentado evita el contacto con las partes rotantes, lo que demuestra la protección para el usuario final mientras le permite la inspección del sello mecánico.

#### Fiabilidad

El cojinete y el eje están diseñados para asegurar la reducción de la tensión, proporcionando alta fiabilidad en todas las condiciones.

## Características constructivas

### NMD

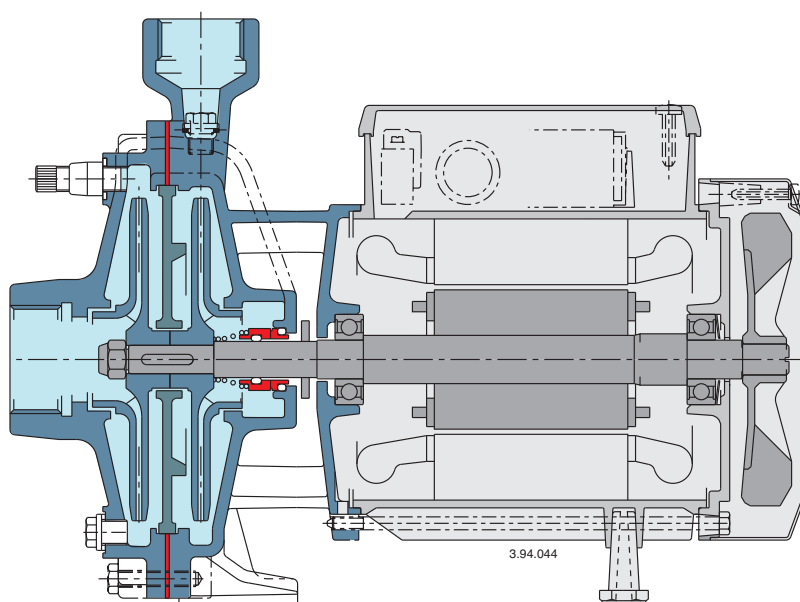

#### Flexibilidad

La opción de elegir entre el hierro fundido y Materias bronce para las partes hidráulicas en contacto con el líquido bombeado permite bombas de la serie NMD a ser seleccionadas para su uso con diferentes tipos de líquidos.

#### Robustez

La estructura mecánica de las partes hidráulicas en contacto con el líquido bombeado están dimensionadas para garantizar la máxima resistencia a la tensión mecánica.

#### Fiabilidad

El cojinete y el eje están diseñados para asegurar la reducción de la tensión, proporcionando alta fiabilidad en todas las condiciones de funcionamiento.